

# MATRIX METHODS: THEORY, ALGORITHMS, APPLICATIONS

Edited by

**Vadim Olshevsky**

*University of Connecticut  
Storrs, USA*

**Eugene Tyrtyshnikov**

*Institute of Numerical Mathematics  
Russian Academy of Sciences  
Moscow, Russia*

World Scientific Publishing • 2008

*To the memory of Gene Golub*

## PREFACE

Among others devoted to matrices, this book is unique in covering the whole of a triptych consisting of algebraic theory, algorithmic problems and numerical applications, all united by the essential use and urge for development of matrix methods. This was the spirit of the 2nd International Conference on Matrix Methods and Operator Equations (23–27 July 2007, Moscow) hosted by the Institute of Numerical Mathematics of Russian Academy of Sciences and organized by Dario Bini, Gene Golub, Alexander Guterman, Vadim Olshevsky, Stefano Serra-Capizzano, Gilbert Strang and Eugene Tyrtysnikov.

Matrix methods provide the key to many problems in pure and applied mathematics. However, it is more usual that linear algebra theory, numerical algorithms and matrices in FEM/BEM applications live as if in three separate worlds. In this book, maybe for the first time at all, they are put together as one entity as it was in the Moscow meeting, where the algebraic part was impersonated by Hans Schneider, algorithms by Gene Golub, and applications by Guri Marchuk. All the topics intervened in plenary sessions and were specialized in three sections, giving names to three chapters of this book.

Among the authors of this book are several top-class experts in numerical mathematics, matrix analysis and linear algebra applications including Dario Bini, Walter Gander, Alexander Guterman, Wolfgang Hackbusch, Khakim Ikramov, Valery Il'in, Igor Kaporin, Boris Khoromskij, Victor Pan, Stefano Serra-Capizzano, Reinhold Schneider, Vladimir Sergeichuk, Harald Wimmer and others.

The book assumes a good basic knowledge of linear algebra and general mathematical background. Besides professionals, it calls as well to a wider audience, in academia and industry, of all those who consider using matrix methods in their work or major in other fields of mathematics, engineering and sciences.

We are pleased to acknowledge that Alexander Guterman engaged in thorough editing “Algebra and Matrices” papers, Maxim Olshanskii and Yuri Vassilevski invested their time and expertise to “Matrices and Applications” part, and Sergei Goreinov committed himself to enormous technical necessities of making the texts into page.

It is much appreciated that the Moscow meeting that gave a base to this book was supported by Russian Foundation for Basic Research, Russian Academy of Sciences, International Foundation for Technology and Investments, Neurok Techsoft, and University of Insubria (Como, Italy).

The soul of the meeting was Gene Golub who rendered a charming “Golub’s dimension” to the three main axes of the conference topics. This book is happening now to come out in his ever lasting, eminently bright and immensely grateful memory.

Vadim Olshevsky

Eugene Tyrtyshnikov

## Table of Contents

<b>Preface</b> .....	v
 <b>Algebra and Matrices</b>	
Operators Preserving Primitivity for Matrix Pairs .....	2
<i>L. B. Beasley (Utah State University), A. E. Guterman (Moscow State University)</i>	
Decompositions of quaternions and their matrix equivalents .....	20
<i>D. Janovská (Institute of Chemical Technology), G. Opfer (University of Hamburg)</i>	
Sensitivity analysis of Hamiltonian and reversible systems prone to dissipation-induced instabilities .....	31
<i>O. N. Kirillov (Moscow State University)</i>	
Block triangular miniversal deformations of matrices and matrix pencils .	69
<i>L. Klimenko (Computing Centre of Ministry of Labour and Social Policy), V. V. Sergeichuk (Institute of Mathematics)</i>	
Determining the Schein rank of Boolean matrices .....	85
<i>E. E. Marenich (Murmansk State Pedagogic University)</i>	
Lattices of matrix rows and matrix columns. Lattices of invariant column eigenvectors. ....	104
<i>V. Marenich (Murmansk State Pedagogic University)</i>	
Matrix algebras and their length .....	116
<i>O. V. Markova (Moscow State University)</i>	
On a New Class of Singular Nonsymmetric Matrices with Nonnegative Integer Spectra .....	140
<i>T. Nahtman (University of Tartu), D. von Rosen (Swedish University of Agricultural Sciences)</i>	
Reduction of a set of matrices over a principal ideal domain to the Smith normal forms by means of the same one-sided transformations ....	166
<i>V. M. Prokip (Institute for Applied Problems of Mechanics and Mathematics)</i>	

## Matrices and Algorithms

Nonsymmetric algebraic Riccati equations associated with an M-matrix: recent advances and algorithms .....	176
<i>D. Bini (University of Pisa), B. Iannazo (University of Insubria), B. Meini (University of Pisa), F. Poloni (Scuola Normale Superiore of Pisa)</i>	
A generalized conjugate direction method for nonsymmetric large ill-conditioned linear systems .....	210
<i>E. R. Boudinov (FORTIS Bank, Brussels), A. I. Manevich (Dnepropetrovsk National University)</i>	
There exist normal Hankel $(\phi, \psi)$ -circulants of any order $n$ .....	222
<i>V. Chugunov (Institute of Numerical Math. RAS), Kh. Ikramov (Moscow State University)</i>	
On the Treatment of Boundary Artifacts in Image Restoration by reflection and/or anti-reflection .....	227
<i>M. Donatelli (University of Insubria), S. Serra-Capizzano (University of Insubria)</i>	
Zeros of Determinants of $\lambda$ -Matrices .....	238
<i>W. Gander (ETH, Zurich)</i>	
How to find a good submatrix .....	247
<i>S. Goreinov (INM RAS), I. Oseledets (INM RAS), D. Savostyanov (INM RAS), E. Tyrtshnikov (INM RAS), N. Zamarashkin (INM RAS)</i>	
Conjugate and Semi-Conjugate Direction Methods with Preconditioning Projectors .....	257
<i>V. Il'in (Novosibirsk Institute of Comp. Math.)</i>	
Some Relationships between Optimal Preconditioner and Superoptimal Preconditioner .....	266
<i>J.-B. Chen (Shanghai Maritime University), X.-Q. Jin (University of Macau), Y.-M. Wei (Fudan University), Zh.-L. Xu (Shanghai Maritime University)</i>	
Scaling, Preconditioning, and Superlinear Convergence in GMRES-type iterations .....	273
<i>I. Kaporin (Computing Center of Russian Academy of Sciences)</i>	

Toeplitz and Toeplitz-block-Toeplitz matrices and their correlation with syzygies of polynomials .....	296
<i>H. Khalil (Institute Camille Jordan), B. Mourrain (INRIA), M. Schatzman (Institute Camille Jordan)</i>	
Concepts of Data-Sparse Tensor-Product Approximation in Many-Particle Modelling .....	313
<i>H.-J. Flad (TU Berlin), W. Hackbusch (Max-Planck-Institute, Leipzig), B. Khoromskij (Max-Planck-Institute, Leipzig), R. Schneider (TU Berlin)</i>	
Separation of variables in nonlinear Fermi equation .....	348
<i>Yu. I. Kuznetsov (Novosibirsk Institute of Comp. Math.)</i>	
Faster Multipoint Polynomial Evaluation via Structured Matrices .....	354
<i>B. Murphy (Lehman College), R. E. Rosholt (Lehman College)</i>	
Testing Pivoting Policies in Gaussian Elimination .....	357
<i>B. Murphy (Lehman College), G. Qian (University of New York), R. E. Rosholt (Lehman College), A.-L. Zheng (University of New York), S. Ngosse (University of New York), I. Taj-Eddin (University of New York)</i>	
Newton's Iteration for Matrix Inversion, Advances and Extensions .....	364
<i>V. Y. Pan (Lehman College)</i>	
Truncated decompositions and filtering methods with Reflective/Anti- Reflective boundary conditions: a comparison .....	382
<i>C. Tablino Possio (University of Milano)</i>	
Discrete-time stability of a class of hermitian polynomial matrices with positive semidefinite coefficients .....	409
<i>H. Wimmer (University of Würzburg)</i>	

## Matrices and Applications

Splitting algorithm for solving mixed variational inequalities with inversely strongly monotone operators .....	416
<i>I. Badriev (Kazan State University), O. Zadornov (Kazan State University)</i>	
Multilevel Algorithm for Graph Partitioning .....	434
<i>N. Bochkarev (Neurok), O. Diyankov (Neurok), V. Pravilnikov (Neurok)</i>	

2D-extension of Singular Spectrum Analysis: algorithm and elements of theory . . . . .	450
<i>N. E. Golyandina (St. Petersburg State University), K. D. Usevich (St. Petersburg State University)</i>	
Application of Radon transform for fast solution of boundary value problems for elliptic PDE in domains with complicated geometry . . . . .	475
<i>A. I. Grebennikov (Autonomous University of Puebla)</i>	
Application of a multigrid method to solving diffusion-type equations . . .	483
<i>M. E. Ladonkina (Institute for Math. Modelling RAS), O. Yu. Milukova (Institute for Math. Modelling RAS), V. F. Tishkin (Institute for Math. Modelling RAS)</i>	
Monotone matrices and finite volume schemes for diffusion problems preserving non-negativity of solution . . . . .	500
<i>I. Kopyrin (Institute of Numerical Math. RAS)</i>	
Sparse Approximation of FEM Matrix for Sheet Current Integro- Differential Equation . . . . .	510
<i>M. Khapaev (Moscow State University), M. Kupriyanov (Nuclear Physics Institute)</i>	
The method of magnetic field computation in presence of an ideal conductive multiconnected surface by using the integro-differential equation of the first kind . . . . .	523
<i>T. Kochubey (Southern Scientific Centre RAS), V. I. Astakhov (Southern Scientific Centre RAS)</i>	
Spectral model order reduction preserving passivity for large multiport RCLM networks . . . . .	533
<i>Yu. M. Nechepurenko (Institute of Numerical Math. RAS), A. S. Potyagalova (Cadence), I. A. Karaseva (Moscow Institute of Physics and Technology)</i>	
New Smoothers in Multigrid Methods for Strongly Nonsymmetric Linear Systems . . . . .	539
<i>G. Muratova (Southern Federal University), E. Andreeva (Southern Federal University)</i>	
Operator equations for eddy currents on singular carriers . . . . .	546
<i>J. Naumenko (Southern Scientific Centre RAS)</i>	
Matrix approach to modelling of polarized radiation transfer in heterogeneous systems . . . . .	557



*T. A. Sushkevich (Keldysh Institute for Applied Mathematics),*  
*S. A. Strelkov (Keldysh Institute for Applied Mathematics),*  
*S. V. Maksakova (Keldysh Institute for Applied Mathematics)*

The Method of Regularization of Tikhonov Based on Augmented Systems 579

*A. I. Zhdanov (Samara State Aerospace University),*  
*T. G. Parchaikina (Samara State Aerospace University)*

**Author Index** ..... 586



# **ALGEBRA AND MATRICES**

# Sensitivity analysis of Hamiltonian and reversible systems prone to dissipation-induced instabilities

Oleg N. Kirillov\*

Institute of Mechanics, Moscow State Lomonosov University, Michurinskii pr. 1,  
119192 Moscow, Russia

`kirillov@imec.msu.ru`;

Department of Mechanical Engineering, Technische Universität Darmstadt,  
Hochschulstr. 1, 64289 Darmstadt, Germany

`kirillov@dyn.tu-darmstadt.de`

**Abstract.** Stability of a linear autonomous non-conservative system in the presence of potential, gyroscopic, dissipative, and non-conservative positional forces is studied. The cases when the non-conservative system is close either to a gyroscopic system or to a circulatory one, are examined. It is known that marginal stability of gyroscopic and circulatory systems can be destroyed or improved up to asymptotic stability due to action of small non-conservative positional and velocity-dependent forces. We show that in both cases the boundary of the asymptotic stability domain of the perturbed system possesses singularities such as “Dihedral angle”, “Break of an edge” and “Whitney's umbrella” that govern stabilization and destabilization as well as are responsible for the imperfect merging of modes. Sensitivity analysis of the critical parameters is performed with the use of the perturbation theory for eigenvalues and eigenvectors of non-self-adjoint operators. In case of two degrees of freedom, stability boundary is found in terms of the invariants of matrices of the system. Bifurcation of the stability domain due to change of the structure of the damping matrix is described. As a mechanical example, the Hauger gyropendulum is analyzed in detail; an instability mechanism in a general mechanical system with two degrees of freedom, which originates after discretization of models of a rotating disc in frictional contact and possesses the spectral mesh in the plane ‘frequency’ versus ‘angular velocity’, is analytically described and its role in the excitation of vibrations in the squealing disc brake and in the singing wine glass is discussed.

*Keywords:* matrix polynomial, Hamiltonian system, reversible system, Lyapunov stability, indefinite damping, perturbation, dissipation-induced instabilities, destabilization paradox, multiple eigenvalue, singularity.

---

\* The work has been partly supported by the Alexander von Humboldt Foundation and by the German Research Foundation, Grant DFG HA 1060/43-1.

## 1 Introduction

Consider an autonomous non-conservative system

$$\ddot{\mathbf{x}} + (\Omega \mathbf{G} + \delta \mathbf{D})\dot{\mathbf{x}} + (\mathbf{K} + \nu \mathbf{N})\mathbf{x} = 0, \quad (1)$$

where dot stands for the time differentiation,  $\mathbf{x} \in \mathbb{R}^m$ , and real matrix  $\mathbf{K} = \mathbf{K}^T$  corresponds to potential forces. Real matrices  $\mathbf{D} = \mathbf{D}^T$ ,  $\mathbf{G} = -\mathbf{G}^T$ , and  $\mathbf{N} = -\mathbf{N}^T$  are related to dissipative (damping), gyroscopic, and non-conservative positional (circulatory) forces with magnitudes controlled by scaling factors  $\delta$ ,  $\Omega$ , and  $\nu$  respectively. A *circulatory* system is obtained from (1) by neglecting velocity-dependent forces

$$\ddot{\mathbf{x}} + (\mathbf{K} + \nu \mathbf{N})\mathbf{x} = 0, \quad (2)$$

while a *gyroscopic* one has no damping and non-conservative positional forces

$$\ddot{\mathbf{x}} + \Omega \mathbf{G}\dot{\mathbf{x}} + \mathbf{K}\mathbf{x} = 0. \quad (3)$$

Circulatory and gyroscopic systems (2) and (3) possess fundamental symmetries that are evident after transformation of equation (1) to the form  $\dot{\mathbf{y}} = \mathbf{A}\mathbf{y}$  with

$$\mathbf{A} = \begin{bmatrix} -\frac{1}{2}\Omega \mathbf{G} & \mathbf{I} \\ \frac{1}{2}\delta\Omega \mathbf{D}\mathbf{G} + \frac{1}{4}\Omega^2 \mathbf{G}^2 - \mathbf{K} - \nu \mathbf{N} & \delta \mathbf{D} - \frac{1}{2}\Omega \mathbf{G} \end{bmatrix}, \quad \mathbf{y} = \begin{bmatrix} \mathbf{x} \\ \dot{\mathbf{x}} + \frac{1}{2}\Omega \mathbf{G}\mathbf{x} \end{bmatrix}, \quad (4)$$

where  $\mathbf{I}$  is the identity matrix.

In the absence of damping and gyroscopic forces ( $\delta = \Omega = 0$ ),  $\mathbf{R}\mathbf{A}\mathbf{R} = -\mathbf{A}$  with

$$\mathbf{R} = \mathbf{R}^{-1} = \begin{bmatrix} \mathbf{I} & 0 \\ 0 & -\mathbf{I} \end{bmatrix}. \quad (5)$$

This means that the matrix  $\mathbf{A}$  has a *reversible* symmetry, and equation (2) describes a reversible dynamical system [16, 19, 33]. Due to this property,

$$\det(\mathbf{A} - \lambda \mathbf{I}) = \det(\mathbf{R}(\mathbf{A} - \lambda \mathbf{I})\mathbf{R}) = \det(\mathbf{A} + \lambda \mathbf{I}), \quad (6)$$

and the eigenvalues of circulatory system (2) appear in pairs  $(-\lambda, \lambda)$ . Without damping and non-conservative positional forces ( $\delta = \nu = 0$ ) the matrix  $\mathbf{A}$  possesses the *Hamiltonian* symmetry  $\mathbf{J}\mathbf{A}\mathbf{J} = \mathbf{A}^T$ , where  $\mathbf{J}$  is a unit symplectic matrix [17, 23, 28]

$$\mathbf{J} = -\mathbf{J}^{-1} = \begin{bmatrix} 0 & \mathbf{I} \\ -\mathbf{I} & 0 \end{bmatrix}. \quad (7)$$

As a consequence,

$$\det(\mathbf{A} - \lambda \mathbf{I}) = \det(\mathbf{J}(\mathbf{A} - \lambda \mathbf{I})\mathbf{J}) = \det(\mathbf{A}^T + \lambda \mathbf{I}) = \det(\mathbf{A} + \lambda \mathbf{I}), \quad (8)$$

which implies that if  $\lambda$  is an eigenvalue of  $\mathbf{A}$  then so is  $-\lambda$ , similarly to the reversible case. Therefore, an equilibrium of a circulatory or of a gyroscopic

system is either unstable or all its eigenvalues lie on the imaginary axis of the complex plane implying marginal stability if they are semi-simple.

In the presence of all the four forces, the Hamiltonian and reversible symmetries are broken and the marginal stability is generally destroyed. Instead, system (1) can be asymptotically stable if its characteristic polynomial

$$P(\lambda) = \det(\mathbf{I}\lambda^2 + (\Omega\mathbf{G} + \delta\mathbf{D})\lambda + \mathbf{K} + \nu\mathbf{N}), \quad (9)$$

satisfies the criterion of Routh and Hurwitz. The most interesting for many applications, ranging from the rotor dynamics [3–5, 14, 25, 27, 30, 31, 48, 49, 59, 62] to physics of the atmosphere [9, 29, 62, 66] and from stability and optimization of structures [8, 10, 11, 15, 22, 26, 33, 39, 54, 55, 65, 69] to friction-induced instabilities and acoustics of friction [40, 42, 61, 67, 71–73, 75, 76], is the situation when system (1) is close either to circulatory system (2) with  $\delta, \Omega \ll \nu$  (*near-reversible system*) or to gyroscopic system (3) with  $\delta, \nu \ll \Omega$  (*near-Hamiltonian system*). The effect of small damping and gyroscopic forces on the stability of circulatory systems as well as the effect of small damping and non-conservative positional forces on the stability of gyroscopic systems are regarded as *paradoxical*, since the stability properties are extremely sensitive to the choice of the perturbation, and the balance of forces resulting in the asymptotic stability is not evident, as it happens in such phenomena as “tippe top inversion”, “rising egg”, and the onset of friction-induced oscillations in the squealing brake and in the singing wine glass [31, 48, 49, 59, 61, 62, 67, 71–73, 75–77].

Historically, Thomson and Tait in 1879 were the first who found that dissipation destroys the gyroscopic stabilization (*dissipation-induced instability*) [1, 28, 62, 66]. A similar effect of non-conservative positional forces on the stability of gyroscopic systems has been established almost a century later by Lakhadanov and Karapetyan [12, 13]. A more sophisticated manifestation of the dissipation-induced instabilities has been discovered by Ziegler on the example of a double pendulum loaded by a follower force with the damping, non-uniformly distributed among the natural modes [8]. Without dissipation, the Ziegler pendulum is a reversible system, which is marginally stable for the loads non-exceeding some critical value. Small dissipation of order  $o(1)$  makes the pendulum either unstable or asymptotically stable with the critical load, which generically is lower than that of the undamped system by the quantity of order  $O(1)$  (*the destabilization paradox*). Similar discontinuous change in the stability domain for the near-Hamiltonian systems has been observed by Holopainen [9, 66] in his study of the effect of dissipation on the stability of baroclinic waves in Earth’s atmosphere, by Hoveijn and Ruijgrok on the example of a rotating shaft on an elastic foundation [30], and by Crandall, who investigated a gyroscopic pendulum with stationary and rotating damping [31]. Contrary to the Ziegler pendulum, the undamped gyropendulum is a gyroscopic system that is marginally stable when its spin exceeds a critical value. Despite the stationary damping, corresponding

to a dissipative velocity-dependent force, destroys the gyroscopic stabilization [1], the Crandall gyropendulum with stationary and rotating damping, where the latter is related to a non-conservative positional force, can be asymptotically stable for the rotation rates exceeding considerably the critical spin of the undamped system. This is an example of the destabilization paradox in the Hamiltonian system.

As it was understood during the last decade, the reason underlying the destabilization paradox is that the multiparameter family of non-normal matrix operators of the system (1) generically possesses the multiple eigenvalues related to singularities of the boundary of the asymptotic stability domain, which were described and classified by Arnold already in 1970-s [17]. Hoveijn and Ruijgrok were, apparently, the first who associated the discontinuous change in the critical load in their example to the singularity Whitney umbrella, existing on the stability boundary [30]. The same singularity on the boundary of the asymptotic stability has been identified for the Ziegler pendulum [47], for the models of disc brakes [72, 76], of the rods loaded by follower force [54, 55], and of the gyropendulums and spinning tops [63, 70]. These examples reflect the general fact that the codimension-1 Hamiltonian (or reversible) Hopf bifurcation can be viewed as a singular limit of the codimension-3 dissipative resonant 1 : 1 normal form and the essential singularity in which these two cases meet is topologically equivalent to Whitney's umbrella (Hamilton meets Hopf under Whitney's umbrella) [45, 66].

Despite the achieved qualitative understanding, the development of the sensitivity analysis for the critical parameters near the singularities, which is essential for controlling the stabilization and destabilization, is only beginning and is involving such modern disciplines as multiparameter perturbation theory of analytical matrix functions [7, 18, 20, 23, 24, 28, 29, 37, 41, 57, 58] and of non-self-adjoint boundary eigenvalue problems [51, 53–55], the theory of the structured pseudospectra of matrix polynomials [56, 73] and the theory of versal deformations of matrix families [30, 45, 47, 60]. The growing number of physical and mechanical applications demonstrating the destabilization paradox due to an interplay of non-conservative effects and the need for a justification for the use of Hamiltonian or reversible models to describe real-world systems that are in fact only near-Hamiltonian or near-reversible requires a unified treatment of this phenomenon.

The goal of the present paper is to find and to analyze the domain of asymptotic stability of system (1) in the space of the parameters  $\delta$ ,  $\Omega$ , and  $\nu$  with special attention to near-reversible and near-Hamiltonian cases. In the subsequent sections we will combine the study of the two-dimensional system, analyzing the Routh-Hurwitz stability conditions, with the perturbative approach to the case of arbitrary large  $m$ . Typical singularities of the stability boundary will be identified. Bifurcation of the domain of asymptotic stability due to change of

the structure of the matrix  $\mathbf{D}$  of dissipative forces will be thoroughly analyzed and the effect of gyroscopic stabilization of a dissipative system with indefinite damping and non-conservative positional forces will be described. The estimates of the critical parameters and explicit expressions, approximating the boundary of the asymptotic stability domain, will be extended to the case of  $m > 2$  degrees of freedom with the use of the perturbation theory of multiple eigenvalues of non-self-adjoint operators. In the last section the general theory will be applied to the study of the onset of stabilization and destabilization in the models of gyropendulums and disc brakes.

## 2 A circulatory system with small velocity-dependent forces

We begin with the near-reversible case ( $\delta, \Omega \ll \nu$ ), which covers Ziegler's and Nikolai's pendulums loaded by the follower force [8, 10, 11, 33, 47, 43, 44, 53, 66] (their continuous analogue is the viscoelastic Beck column [10, 39, 54, 55]), the Reut-Sugiyama pendulum [50], the low-dimensional models of disc brakes by North [67, 73], Popp [40], and Sinou and Jezequel [72], the model of a mass sliding over a conveyor belt by Hoffmann and Gaul [42], the models of rotors with internal and external damping by Kimball and Smith [3, 4] and Kapitsa [5, 66], and finds applications even in the modeling of the two-legged walking and of the dynamics of space tethers [32].

### 2.1 Stability of a circulatory system

Stability of system (1) is determined by its characteristic polynomial (8), which in case of two degrees of freedom has a convenient form provided by the Leverrier-Barnett algorithm [21]

$$P(\lambda, \delta, \nu, \Omega) = \lambda^4 + \delta \operatorname{tr} \mathbf{D} \lambda^3 + (\operatorname{tr} \mathbf{K} + \delta^2 \det \mathbf{D} + \Omega^2) \lambda^2 + (\delta(\operatorname{tr} \mathbf{K} \operatorname{tr} \mathbf{D} - \operatorname{tr} \mathbf{K} \mathbf{D}) + 2\Omega\nu) \lambda + \det \mathbf{K} + \nu^2, \quad (10)$$

where without loss of generality we assume that  $\det \mathbf{G} = 1$  and  $\det \mathbf{N} = 1$ .

In the absence of damping and gyroscopic forces ( $\delta = \Omega = 0$ ) the system (1) is circulatory, and the polynomial (10) has four roots  $-\lambda_+$ ,  $-\lambda_-$ ,  $\lambda_-$ , and  $\lambda_+$ , where

$$\lambda_{\pm} = \sqrt{-\frac{1}{2} \operatorname{tr} \mathbf{K} \pm \frac{1}{2} \sqrt{(\operatorname{tr} \mathbf{K})^2 - 4(\det \mathbf{K} + \nu^2)}}. \quad (11)$$

The eigenvalues (11) can be real, complex or purely imaginary implying instability or marginal stability in accordance with the following statement.

**Proposition 1.** *If  $\operatorname{tr} \mathbf{K} > 0$  and  $\det \mathbf{K} \leq 0$ , circulatory system (2) with two degrees of freedom is stable for  $\nu_d^2 < \nu^2 < \nu_r^2$ , unstable by divergence for*



$\nu^2 \leq \nu_d^2$ , and unstable by flutter for  $\nu^2 \geq \nu_f^2$ , where the critical values  $\nu_d$  and  $\nu_f$  are

$$0 \leq \sqrt{-\det \mathbf{K}} =: \nu_d \leq \nu_f := \frac{1}{2} \sqrt{(\text{tr} \mathbf{K})^2 - 4 \det \mathbf{K}}. \quad (12)$$

If  $\text{tr} \mathbf{K} > 0$  and  $\det \mathbf{K} > 0$ , the circulatory system is stable for  $\nu^2 < \nu_f^2$  and unstable by flutter for  $\nu^2 \geq \nu_f^2$ .

If  $\text{tr} \mathbf{K} \leq 0$ , the system is unstable.

The proof is a consequence of formula (11), reversible symmetry, and the fact that time dependence of solutions of equation (2) is given by  $\exp(\lambda t)$  for simple eigenvalues  $\lambda$ , with an additional—polynomial in  $t$ —prefactor (secular terms) in case of multiple eigenvalues with the Jordan block. The solutions monotonously grow for positive real  $\lambda$  implying static instability (divergence), oscillate with an increasing amplitude for complex  $\lambda$  with positive real part (flutter), and remain bounded when  $\lambda$  is semi-simple and purely imaginary (stability). For  $\mathbf{K}$ , having two equal eigenvalues,  $\nu_f = 0$  and the circulatory system (2) is unstable in agreement with the Merkin theorem for circulatory systems with two degrees of freedom [34, 62].

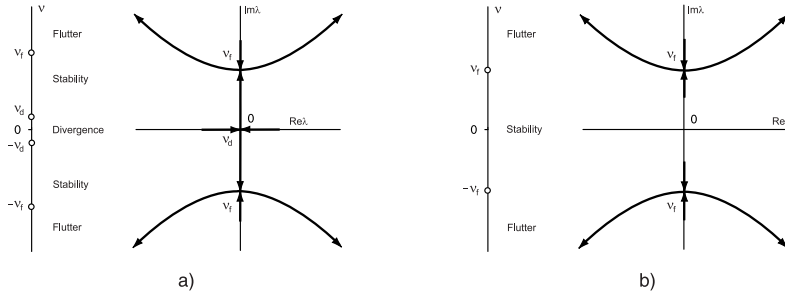

**Fig. 1.** Stability diagrams and trajectories of eigenvalues for the increasing parameter  $\nu > 0$  for the circulatory system (2) with  $\text{tr} \mathbf{K} > 0$  and  $\det \mathbf{K} < 0$  (a) and  $\text{tr} \mathbf{K} > 0$  and  $\det \mathbf{K} > 0$  (b).

Stability diagrams and motion of eigenvalues in the complex plane for  $\nu$  increasing from zero are presented in Fig. 1. When  $\text{tr} \mathbf{K} > 0$  and  $\det \mathbf{K} < 0$  there are two real and two purely imaginary eigenvalues at  $\nu = 0$ , and the system is statically unstable, see Fig. 1(a). With the increase of  $\nu$  both the imaginary and real eigenvalues are moving to the origin, until at  $\nu = \nu_d$  the real pair merges and originates a double zero eigenvalue with the Jordan block. At  $\nu = \nu_d$  the system is unstable due to linear time dependence of a solution corresponding to  $\lambda = 0$ . The further increase of  $\nu$  yields splitting of the double zero eigenvalue

into two purely imaginary ones. The imaginary eigenvalues of the same sign are then moving towards each other until at  $\nu = \nu_f$  they originate a pair of double eigenvalues  $\pm i\omega_f$  with the Jordan block, where

$$\omega_f = \sqrt{\frac{1}{2}\text{tr}\mathbf{K}}. \quad (13)$$

At  $\nu = \nu_f$  the system is unstable by flutter due to secular terms in its solutions. For  $\nu > \nu_f$  the flutter instability is caused by two of the four complex eigenvalues lying on the branches of a hyperbolic curve

$$\text{Im}\lambda^2 - \text{Re}\lambda^2 = \omega_f^2. \quad (14)$$

The critical values  $\nu_d$  and  $\nu_f$  constitute the boundaries between the divergence and stability domains and between the stability and flutter domains respectively. For  $\text{tr}\mathbf{K} > 0$  and  $\det\mathbf{K} = 0$  the divergence domain shrinks to a point  $\nu_d = 0$  and for  $\text{tr}\mathbf{K} > 0$  and  $\det\mathbf{K} > 0$  there exist only stability and flutter domains as shown in Fig. 1(b). For negative  $\nu$  the boundaries of the divergence and flutter domains are  $\nu = -\nu_d$  and  $\nu = -\nu_f$ .

In general, the Jordan chain for the eigenvalue  $i\omega_f$  consists of an eigenvector  $\mathbf{u}_0$  and an associated vector  $\mathbf{u}_1$  that satisfy the equations [53]

$$(-\omega_f^2\mathbf{I} + \mathbf{K} + \nu_f\mathbf{N})\mathbf{u}_0 = 0, \quad (-\omega_f^2\mathbf{I} + \mathbf{K} + \nu_f\mathbf{N})\mathbf{u}_1 = -2i\omega_f\mathbf{u}_0. \quad (15)$$

Due to the non-self-adjointness of the matrix operator, the same eigenvalue possesses the left Jordan chain of generalized eigenvectors  $\mathbf{v}_0$  and  $\mathbf{v}_1$

$$\mathbf{v}_0^\top(-\omega_f^2\mathbf{I} + \mathbf{K} + \nu_f\mathbf{N}) = 0, \quad \mathbf{v}_1^\top(-\omega_f^2\mathbf{I} + \mathbf{K} + \nu_f\mathbf{N}) = -2i\omega_f\mathbf{v}_0^\top. \quad (16)$$

The eigenvalues  $\mathbf{u}_0$  and  $\mathbf{v}_0$  are biorthogonal

$$\mathbf{v}_0^\top\mathbf{u}_0 = 0. \quad (17)$$

In the neighborhood of  $\nu = \nu_f$  the double eigenvalue and the corresponding eigenvectors vary according to the formulas [52, 53]

$$\begin{aligned} \lambda(\nu) &= i\omega_f \pm \mu\sqrt{\nu - \nu_f} + o((\nu - \nu_f)^{\frac{1}{2}}), \\ \mathbf{u}(\nu) &= \mathbf{u}_0 \pm \mu\mathbf{u}_1\sqrt{\nu - \nu_f} + o((\nu - \nu_f)^{\frac{1}{2}}), \\ \mathbf{v}(\nu) &= \mathbf{v}_0 \pm \mu\mathbf{v}_1\sqrt{\nu - \nu_f} + o((\nu - \nu_f)^{\frac{1}{2}}), \end{aligned} \quad (18)$$

where  $\mu^2$  is a real number given by

$$\mu^2 = -\frac{\mathbf{v}_0^\top\mathbf{N}\mathbf{u}_0}{2i\omega_f\mathbf{v}_0^\top\mathbf{u}_1}. \quad (19)$$

For  $m = 2$  the generalized eigenvectors of the right and left Jordan chains at the eigenvalue  $i\omega_f$ , where the eigenfrequency is given by (13) and the critical value  $\nu_f$  is defined by (12), are [52]

$$\mathbf{u}_0 = \begin{bmatrix} 2k_{12} + 2\nu_f \\ k_{22} - k_{11} \end{bmatrix}, \quad \mathbf{v}_0 = \begin{bmatrix} 2k_{12} - 2\nu_f \\ k_{22} - k_{11} \end{bmatrix}, \quad \mathbf{u}_1 = \mathbf{v}_1 = \begin{bmatrix} 0 \\ -4i\omega_f \end{bmatrix}. \quad (20)$$

Substituting (20) into equation (19) yields the expression

$$\mu^2 = -\frac{4\nu_f(k_{11} - k_{22})}{2i\omega_f \mathbf{v}_0^T \mathbf{u}_1} = \frac{\nu_f}{2\omega_f^2} > 0. \quad (21)$$

After plugging the real-valued coefficient  $\mu$  into expansions (18) we obtain an approximation of order  $|\nu - \nu_f|^{1/2}$  of the exact eigenvalues  $\lambda = \lambda(\nu)$ . This can be verified by the series expansions of (11) about  $\nu = \nu_f$ .

## 2.2 The influence of small damping and gyroscopic forces on the stability of a circulatory system

The one-dimensional domain of marginal stability of circulatory system (2) given by Proposition 1 blows up into a three-dimensional domain of asymptotic stability of system (1) in the space of the parameters  $\delta$ ,  $\Omega$ , and  $\nu$ , which is described by the Routh and Hurwitz criterion for the polynomial (10)

$$\delta \operatorname{tr} \mathbf{D} > 0, \quad \operatorname{tr} \mathbf{K} + \delta^2 \det \mathbf{D} + \Omega^2 > 0, \quad \det \mathbf{K} + \nu^2 > 0, \quad Q(\delta, \Omega, \nu) > 0, \quad (22)$$

where

$$\begin{aligned} Q &:= -q^2 + \delta \operatorname{tr} \mathbf{D} (\operatorname{tr} \mathbf{K} + \delta^2 \det \mathbf{D} + \Omega^2) q - (\delta \operatorname{tr} \mathbf{D})^2 (\det \mathbf{K} + \nu^2), \\ q &:= \delta (\operatorname{tr} \mathbf{K} \operatorname{tr} \mathbf{D} - \operatorname{tr} \mathbf{K} \mathbf{D}) + 2\Omega \nu. \end{aligned} \quad (23)$$

Considering the asymptotic stability domain (22) in the space of the parameters  $\delta$ ,  $\nu$  and  $\Omega$  we remind that the initial system (1) is equivalent to the first-order system with the real  $2m \times 2m$  matrix  $\mathbf{A}(\delta, \nu, \Omega)$  defined by expression (4). As it was established by Arnold [17], the boundary of the asymptotic stability domain of a multiparameter family of real matrices is not a smooth surface. Generically, it possesses singularities corresponding to multiple eigenvalues with zero real part. Applying the qualitative results of [17], we deduce that the parts of the  $\nu$ -axis belonging to the stability domain of system (2) and corresponding to two different pairs of simple purely imaginary eigenvalues, form edges of the *dihedral angles* on the surfaces that bound the asymptotic stability domain of system (1), see Fig. 2(a). At the points  $\pm \nu_f$  of the  $\nu$ -axis, corresponding to the stability-flutter boundary of system (2) there exists a pair of double purely imaginary eigenvalues with the Jordan block. Qualitatively, the asymptotic stability domain of system (1) in the space  $(\delta, \nu, \Omega)$  near the  $\nu$ -axis looks like a dihedral

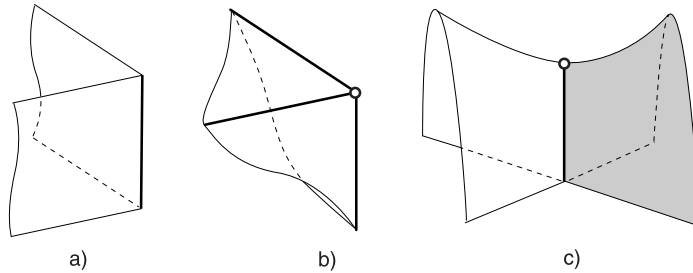

**Fig. 2.** Singularities *dihedral angle* (a), *trihedral angle* (b), and *deadlock of an edge* (or a half of the *Whitney umbrella* (c)) of the boundary of the asymptotic stability domain.

angle which becomes more acute while approaching the points  $\pm v_f$ . At these points the angle shrinks forming the *deadlock of an edge*, which is a half of the *Whitney umbrella* surface [17, 30, 45], see Fig. 2(c). In case when the stability domain of the circulatory system has a common boundary with the divergence domain, as shown in Fig. 1(a), the boundary of the asymptotic stability domain of the perturbed system (1) possesses the *trihedral angle* singularity at  $v = \pm v_d$ , see Fig. 2(b).

The first two of the conditions of asymptotic stability (22) restrict the region of variation of parameters  $\delta$  and  $\Omega$  either to a half-plane  $\delta \text{tr} \mathbf{D} > 0$ , if  $\det \mathbf{D} \geq 0$ , or to a space between the line  $\delta = 0$  and one of the branches of a hyperbola  $|\det \mathbf{D}| \delta^2 - \Omega^2 = 2\omega_f^2$ , if  $\det \mathbf{D} < 0$ . Provided that  $\delta$  and  $\Omega$  belong to the described domain, the asymptotic stability of system (1) is determined by the last two of the inequalities (22), which impose limits on the variation of  $v$ . Solving the quadratic in  $v$  equation  $Q(\delta, v, \Omega) = 0$  we write the stability condition  $Q > 0$  in the form

$$(v - v_{cr}^-)(v - v_{cr}^+) < 0, \quad (24)$$

with

$$v_{cr}^\pm(\delta, \Omega) = \frac{\Omega b \pm \sqrt{\Omega^2 b^2 + ac}}{a} \delta. \quad (25)$$

The coefficients  $a$ ,  $b$ , and  $c$  are

$$\begin{aligned} a(\delta, \Omega) &= 4\Omega^2 + \delta^2(\text{tr} \mathbf{D})^2, & b(\delta, \Omega) &= 4v_f \beta_* + (\delta^2 \det \mathbf{D} + \Omega^2) \text{tr} \mathbf{D}, \\ c(\delta, \Omega) &= v_f^2((\text{tr} \mathbf{D})^2 - 4\beta_*^2) + (\omega_f^2 \text{tr} \mathbf{D} - 2v_f \beta_*)(\delta^2 \det \mathbf{D} + \Omega^2) \text{tr} \mathbf{D}, \end{aligned} \quad (26)$$

where

$$\beta_* := \frac{\text{tr}(\mathbf{K} - \omega_f^2 \mathbf{I}) \mathbf{D}}{2v_f}. \quad (27)$$

For  $\det \mathbf{K} \leq 0$ , the domain of asymptotic stability consists of two non-intersecting parts, bounded by the surfaces  $v = v_{cr}^\pm(\delta, \Omega)$  and by the planes  $v = \pm v_d$ ,

separating it from the divergence domain. For  $\det \mathbf{K} > 0$ , inequality  $\det \mathbf{K} + \nu^2 > 0$  is fulfilled, and in accordance with the condition (24) the asymptotic stability domain is contained between the surfaces  $\nu = \nu_{\text{cr}}^+(\delta, \Omega)$  and  $\nu = \nu_{\text{cr}}^-(\delta, \Omega)$ .

The functions  $\nu_{\text{cr}}^\pm(\delta, \Omega)$  defined by expressions (25) are singular at the origin due to vanishing denominator. Assuming  $\Omega = \beta\delta$  and calculating a limit of these functions when  $\delta$  tends to zero, we obtain

$$\nu_0^\pm(\beta) := \lim_{\delta \rightarrow 0} \nu_{\text{cr}}^\pm = \nu_f \frac{4\beta\beta_* \pm \text{tr} \mathbf{D} \sqrt{(\text{tr} \mathbf{D})^2 + 4(\beta^2 - \beta_*^2)}}{(\text{tr} \mathbf{D})^2 + 4\beta^2}. \quad (28)$$

The functions  $\nu_0^\pm(\beta)$  are real-valued if the radicand in (28) is non-negative.

**Proposition 2.** *Let  $\lambda_1(\mathbf{D})$  and  $\lambda_2(\mathbf{D})$  be eigenvalues of  $\mathbf{D}$ . Then,*

$$|\beta_*| \leq \frac{|\lambda_1(\mathbf{D}) - \lambda_2(\mathbf{D})|}{2}. \quad (29)$$

If  $\mathbf{D}$  is semi-definite ( $\det \mathbf{D} \geq 0$ ) or indefinite with

$$0 > \det \mathbf{D} \geq -\frac{(k_{12}(d_{22} - d_{11}) - d_{12}(k_{22} - k_{11}))^2}{4\nu_f^2}, \quad (30)$$

then

$$|\beta_*| \leq \frac{|\text{tr} \mathbf{D}|}{2}, \quad (31)$$

and the limits  $\nu_0^\pm(\beta)$  are continuous real-valued functions of  $\beta$ . Otherwise, there exists an interval of discontinuity  $\beta^2 < \beta_*^2 - (\text{tr} \mathbf{D})^2/4$ .

*Proof.* With the use of the definition of  $\beta_*$ , (27), a series of transformations

$$\begin{aligned} \beta_*^2 - \frac{(\text{tr} \mathbf{D})^2}{4} &= \frac{1}{4\nu_f^2} \left( \frac{(k_{11} - k_{22})(d_{11} - d_{22})}{2} + 2k_{12}d_{12} \right)^2 \\ &\quad - \frac{(d_{11} + d_{22})^2 ((k_{11} - k_{22})^2 + 4k_{12}^2)}{4 \cdot 4\nu_f^2} \\ &= -\det \mathbf{D} - \frac{(k_{12}(d_{22} - d_{11}) - d_{12}(k_{22} - k_{11}))^2}{4\nu_f^2} \end{aligned} \quad (32)$$

yields the expression

$$\beta_*^2 = \frac{(\lambda_1(\mathbf{D}) - \lambda_2(\mathbf{D}))^2}{4} - \frac{(k_{12}(d_{22} - d_{11}) - d_{12}(k_{22} - k_{11}))^2}{4\nu_f^2}. \quad (33)$$

For real  $\beta_*$ , formula (32) implies inequality (30). The remaining part of the proposition follows from (33).

Inequality (30) subdivides the set of indefinite damping matrices into two classes.

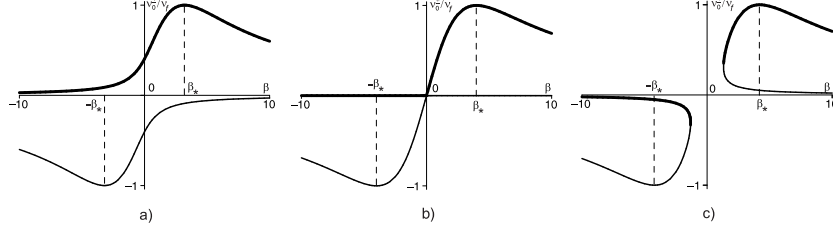

**Fig. 3.** The functions  $\nu_0^+(\beta)$  (bold lines) and  $\nu_0^-(\beta)$  (fine lines), and their bifurcation when  $\mathbf{D}$  is changing from weakly- to strongly indefinite.

**Definition 1.** We call a  $2 \times 2$  real symmetric matrix  $\mathbf{D}$  with  $\det \mathbf{D} < 0$  weakly indefinite, if  $4\beta_*^2 < (\text{tr} \mathbf{D})^2$ , and strongly indefinite, if  $4\beta_*^2 > (\text{tr} \mathbf{D})^2$ .

As an illustration, we calculate and plot the functions  $\nu_0^\pm(\beta)$ , normalized by  $\nu_f$ , for the matrix  $\mathbf{K} > 0$  and indefinite matrices  $\mathbf{D}_1$ ,  $\mathbf{D}_2$ , and  $\mathbf{D}_3$

$$\mathbf{K} = \begin{bmatrix} 27 & 3 \\ 3 & 5 \end{bmatrix}, \quad \mathbf{D}_1 = \begin{bmatrix} 6 & 3 \\ 3 & 1 \end{bmatrix}, \quad \mathbf{D}_2 = \begin{bmatrix} 7 & \frac{4}{3}\sqrt{130} - 11 \\ \frac{4}{3}\sqrt{130} - 11 & 1 \end{bmatrix}, \quad \mathbf{D}_3 = \begin{bmatrix} 7 & 5 \\ 5 & 1 \end{bmatrix}. \quad (34)$$

The graphs of the functions  $\nu_0^\pm(\beta)$  bifurcate with a change of the damping matrix from the weakly indefinite to the strongly indefinite one. Indeed, since  $\mathbf{D}_1$  satisfies the strict inequality (30), the limits are continuous functions with separated graphs, as shown in Fig. 3(a). Expression (30) is an equality for the matrix  $\mathbf{D}_2$ . Consequently, the functions  $\nu_0^\pm(\beta)$  are continuous, with their graphs touching each other at the origin, Fig. 3(b). For the matrix  $\mathbf{D}_3$ , condition (30) is not fulfilled, and the functions are discontinuous. Their graphs, however, are joint together, forming continuous curves, see Fig. 3(c). The calculated  $\nu_0^\pm(\beta)$  are bounded functions of  $\beta$ , non-exceeding the critical values  $\pm\nu_f$  of the unperturbed circulatory system.

**Proposition 3.**

$$|\nu_0^\pm(\beta)| \leq |\nu_0^\pm(\pm\beta_*)| = \nu_f. \quad (35)$$

*Proof.* Let us observe that  $\mu_0^\pm := \nu_0^\pm/\nu_f$  are roots of the quadratic equation

$$\nu_f^2 a_\beta \mu^2 - 2\delta\Omega b_0 \nu_f \mu - \delta^2 c_0 = 0, \quad (36)$$

with  $\delta^2 a_\beta := a(\delta, \beta\delta)$ ,  $b_0 := b(0, 0)$ ,  $c_0 := c(0, 0)$ . According to the Schur criterion [6] all the roots  $\mu$  of equation (36) are inside the closed unit disk, if

$$\begin{aligned} \delta^2 c_0 + \nu_f^2 a_\beta &= (\text{tr} \mathbf{D})^2 + 4(\beta^2 - \beta_*^2) + (\text{tr} \mathbf{D})^2 \geq 0, \\ 2\delta\Omega \nu_f b_0 + \nu_f^2 a_\beta - \delta^2 c_0 &= (\beta + \beta_*)^2 \geq 0, \\ -2\delta\Omega \nu_f b_0 + \nu_f^2 a_\beta - \delta^2 c_0 &= (\beta - \beta_*)^2 \geq 0. \end{aligned} \quad (37)$$

The first of conditions (37) is satisfied for real  $\nu_0^\pm$ , implying  $|\mu_0^\pm(\beta)| \leq 1$  with  $|\mu_0^+(\beta_*)| = |\mu_0^-(-\beta_*)| = 1$ .

The limits  $\nu_0^\pm(\beta)$  of the critical values of the circulatory parameter  $\nu_{\text{cr}}^\pm(\delta, \Omega)$ , which are complicated functions of  $\delta$  and  $\Omega$ , effectively depend only on the ratio  $\beta = \Omega/\delta$ , defining the direction of approaching zero in the plane  $(\delta, \Omega)$ . Along the directions  $\beta = \beta_*$  and  $\beta = -\beta_*$ , the limits coincide with the critical flutter loads of the unperturbed circulatory system (2) in such a way that  $\nu_0^+(\beta_*) = \nu_f$  and  $\nu_0^-(-\beta_*) = -\nu_f$ . According to Proposition 3, the limit of the non-conservative positional force at the onset of flutter for system (1) with dissipative and gyroscopic forces tending to zero does not exceed the critical flutter load of circulatory system (2), demonstrating a jump in the critical load which is characteristic of the destabilization paradox.

Power series expansions of the functions  $\nu_0^\pm(\beta)$  around  $\beta = \pm\beta_*$  (with the radius of convergence not exceeding  $|\text{tr}\mathbf{D}|/2$ ) yield simple estimates of the jumps in the critical load for the two-dimensional system (1)

$$\nu_f \mp \nu_0^\pm(\beta) = \nu_f \frac{2}{(\text{tr}\mathbf{D})^2} (\beta \mp \beta_*)^2 + o((\beta \mp \beta_*)^2). \quad (38)$$

Leaving in expansions (38) only the second order terms and then substituting  $\beta = \Omega/\delta$ , we get equations of the form  $Z = X^2/Y^2$ , which is canonical for the Whitney umbrella surface [17, 30, 45]. These equations approximate the boundary of the asymptotic stability domain of system (1) in the vicinity of the points  $(0, 0, \pm\nu_f)$  in the space of the parameters  $(\delta, \Omega, \nu)$ . An extension to the case when the system (1) has  $m$  degrees of freedom is given by the following statement.

**Theorem 1.** *Let the system (2) with  $m$  degrees of freedom be stable for  $\nu < \nu_f$  and let at  $\nu = \nu_f$  its spectrum contain a double eigenvalue  $i\omega_f$  with the left and right Jordan chains of generalized eigenvectors  $\mathbf{u}_0, \mathbf{u}_1$  and  $\mathbf{v}_0, \mathbf{v}_1$ , satisfying equations (15) and (16). Define the real quantities*

$$\begin{aligned} d_1 &= \text{Re}(\mathbf{v}_0^\top \mathbf{D} \mathbf{u}_0), & d_2 &= \text{Im}(\mathbf{v}_0^\top \mathbf{D} \mathbf{u}_1 + \mathbf{v}_1^\top \mathbf{D} \mathbf{u}_0), \\ g_1 &= \text{Re}(\mathbf{v}_0^\top \mathbf{G} \mathbf{u}_0), & g_2 &= \text{Im}(\mathbf{v}_0^\top \mathbf{G} \mathbf{u}_1 + \mathbf{v}_1^\top \mathbf{G} \mathbf{u}_0), \end{aligned} \quad (39)$$

and

$$\beta_* = -\frac{\mathbf{v}_0^\top \mathbf{D} \mathbf{u}_0}{\mathbf{v}_0^\top \mathbf{G} \mathbf{u}_0}. \quad (40)$$

Then, in the vicinity of  $\beta := \Omega/\delta = \beta_*$  the limit of the critical flutter load  $\nu_{\text{cr}}^+$  of the near-reversible system with  $m$  degrees of freedom as  $\delta \rightarrow 0$  is

$$\nu_0^+(\beta) = \nu_f - \frac{g_1^2(\beta - \beta_*)^2}{\mu^2(d_2 + \beta_* g_2)^2} + o((\beta - \beta_*)^2). \quad (41)$$

*Proof.* Perturbing a simple eigenvalue  $i\omega(\nu)$  of the stable system (2) at a fixed  $\nu < \nu_f$  by small dissipative and gyroscopic forces yields the increment

$$\lambda = i\omega - \frac{\mathbf{v}^T \mathbf{D} \mathbf{u}}{2\mathbf{v}^T \mathbf{u}} \delta - \frac{\mathbf{v}^T \mathbf{G} \mathbf{u}}{2\mathbf{v}^T \mathbf{u}} \Omega + o(\delta, \Omega). \quad (42)$$

Since the eigenvectors  $\mathbf{u}(\nu)$  and  $\mathbf{v}(\nu)$  can be chosen real, the first order increment is real-valued. Therefore, in the first approximation in  $\delta$  and  $\Omega$ , the simple eigenvalue  $i\omega(\nu)$  remains on the imaginary axis if  $\Omega = \beta(\nu)\delta$ , where

$$\beta(\nu) = -\frac{\mathbf{v}^T(\nu) \mathbf{D} \mathbf{u}(\nu)}{\mathbf{v}^T(\nu) \mathbf{G} \mathbf{u}(\nu)}. \quad (43)$$

Substituting expansions (18) into formula (43), we obtain

$$\beta(\nu) = -\frac{d_1 \pm d_2 \mu \sqrt{\nu_f - \nu} + o(\sqrt{\nu_f - \nu})}{g_1 \pm g_2 \mu \sqrt{\nu_f - \nu} + o(\sqrt{\nu_f - \nu})}, \quad (44)$$

wherefrom expression (41) follows, if  $|\beta - \beta_*| \ll 1$ .

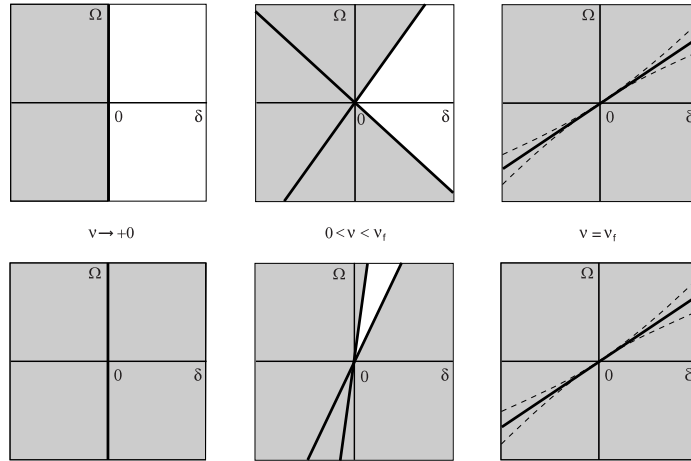

**Fig. 4.** For various  $\nu$ , bold lines show linear approximations to the boundary of the asymptotic stability domain (white) of system (1) in the vicinity of the origin in the plane  $(\delta, \Omega)$ , when  $\text{tr} \mathbf{K} > 0$  and  $\det \mathbf{K} > 0$ , and  $4\beta_*^2 < (\text{tr} \mathbf{D})^2$  (upper row) or  $4\beta_*^2 > (\text{tr} \mathbf{D})^2$  (lower row).

After substituting  $\beta = \Omega/\delta$  the formula (41) gives an approximation of the critical flutter load

$$\nu_{\text{cr}}^+(\delta, \Omega) = \nu_f - \frac{g_1^2 (\Omega - \beta_* \delta)^2}{\mu^2 (d_2 + \beta_* g_2)^2 \delta^2}, \quad (45)$$



which has the canonical Whitney's umbrella form. The coefficients (21) and (39) calculated with the use of vectors (20) are

$$\begin{aligned} d_1 &= 2(k_{22} - k_{11})\text{tr}(\mathbf{K} - \omega_f^2 \mathbf{I})\mathbf{D}, & g_1 &= 4(k_{11} - k_{22})\nu_f \\ d_2 &= -8\omega_f(2d_{12}k_{12} + d_{22}(k_{22} - k_{11})), & g_2 &= 16\omega_f\nu_f. \end{aligned} \quad (46)$$

With (46) expression (41) is reduced to (38).

Using exact expressions for the functions  $\omega(\nu)$ ,  $\mathbf{u}(\nu)$ , and  $\mathbf{v}(\nu)$ , we obtain better estimates in case when  $m = 2$ . Substituting the explicit expression for the eigenfrequency

$$\omega^2(\nu) = \omega_f^2 \pm \sqrt{\nu_f^2 - \nu^2}, \quad (47)$$

following from (11)–(13), into the equation (43), which now reads

$$\delta(2\nu_f\beta_* + (\omega^2(\nu) - \omega_f^2)\text{tr}\mathbf{D}) - 2\Omega\nu = 0, \quad (48)$$

we obtain

$$\Omega = \frac{\nu_f}{\nu} \left[ \beta_* \pm \frac{\text{tr}\mathbf{D}}{2} \sqrt{1 - \frac{\nu^2}{\nu_f^2}} \right] \delta. \quad (49)$$

Equation (49) is simply formula (28) inverted with respect to  $\beta = \Omega/\delta$ .

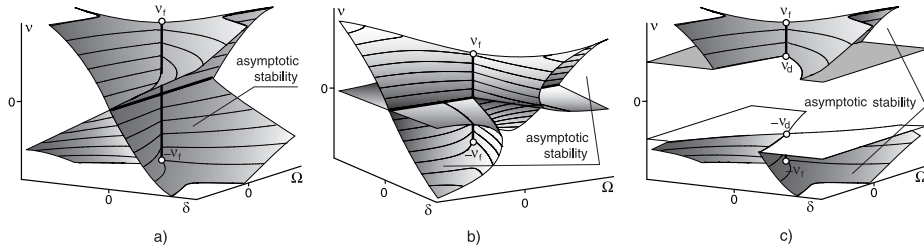

**Fig. 5.** The domain of asymptotic stability of system (1) with the singularities *Whitney umbrella*, *dihedral angle*, and *trihedral angle* when  $\mathbf{K} > 0$  and  $4\beta_*^2 < (\text{tr}\mathbf{D})^2$  (a),  $\mathbf{K} > 0$  and  $4\beta_*^2 > (\text{tr}\mathbf{D})^2$  (b), and when  $\text{tr}\mathbf{K} > 0$  and  $\det \mathbf{K} < 0$  (c).

We use the linear approximation (49) to study the asymptotic behavior of the stability domain of the two-dimensional system (1) in the vicinity of the origin in the plane  $(\delta, \Omega)$  for various  $\nu$ . It is enough to consider only the case when  $\text{tr}\mathbf{K} > 0$  and  $\det \mathbf{K} > 0$ , so that  $-\nu_f < \nu < \nu_f$ , because for  $\det \mathbf{K} \leq 0$  the region  $\nu^2 < \nu_d^2 \leq \nu_f^2$  is unstable and should be excluded.

For  $\nu^2 < \nu_f^2$  the radicand in expression (49) is real and nonzero, so that in the first approximation the domain of asymptotic stability is contained between two lines intersecting at the origin, as depicted in Fig. 4 (central column). When

$\nu$  approaches the critical values  $\pm\nu_f$ , the angle becomes more acute until at  $\nu = \nu_f$  or  $\nu = -\nu_f$  it degenerates to a single line  $\Omega = \delta\beta_*$  or  $\Omega = -\delta\beta_*$  respectively. For  $\beta_* \neq 0$  these lines are not parallel to each other, and due to inequality (31) they are never vertical, see Fig. 4 (right column). However, the degeneration can be lifted already in the second-order approximation in  $\delta$

$$\Omega = \pm\delta\beta_* \pm \frac{\omega_f \text{tr} \mathbf{D} \sqrt{\det \mathbf{D} + \beta_*^2}}{2\nu_f} \delta^2 + O(\delta^3). \quad (50)$$

If the radicand is positive, equation (50) defines two curves touching each other at the origin, as shown in Fig. 4 by dashed lines. Inside the cusps  $|\nu_{\text{cr}}^\pm(\delta, \Omega)| \geq \nu_f$ .

The evolution of the domain of asymptotic stability in the plane  $(\delta, \Omega)$ , when  $\nu$  goes from  $\pm\nu_f$  to zero, depends on the structure of the matrix  $\mathbf{D}$  and is governed by the sign of the expression  $4\beta_*^2 - (\text{tr} \mathbf{D})^2$ . For the negative sign the angle between the lines (49) is getting wider, tending to  $\pi$  as  $\nu \rightarrow 0$ , see Fig. 4 (upper left). Otherwise, the angle reaches a maximum for some  $\nu^2 < \nu_f^2$  and then shrinks to a single line  $\delta = 0$  at  $\nu = 0$ , Fig. 4 (lower left). At  $\nu = 0$  the  $\Omega$ -axis corresponds to a marginally stable gyroscopic system. Since the linear approximation to the asymptotic stability domain does not contain the  $\Omega$ -axis at any  $\nu \neq 0$ , small gyroscopic forces cannot stabilize a circulatory system in the absence of damping forces ( $\delta = 0$ ), which is in agreement with the theorems of Lakhadanov and Karapetyan [12, 13].

Reconstructing with the use of the obtained results the asymptotic stability domain of system (1), we find that it has three typical configurations in the vicinity of the  $\nu$ -axis in the parameter space  $(\delta, \Omega, \nu)$ . In case of a positive-definite matrix  $\mathbf{K}$  and of a semi-definite or a weakly-indefinite matrix  $\mathbf{D}$  the addition of small damping and gyroscopic forces blows the stability interval of a circulatory system  $\nu^2 < \nu_f^2$  up to a three-dimensional region bounded by the parts of a singular surface  $\nu = \nu_{\text{cr}}^\pm(\delta, \Omega)$ , which belong to the half-space  $\delta \text{tr} \mathbf{D} > 0$ , Fig. 5(a). The stability interval of a circulatory system forms an edge of a dihedral angle. At  $\nu = 0$  the angle of the intersection reaches its maximum ( $\pi$ ), creating another edge along the  $\Omega$ -axis. While approaching the points  $\pm\nu_f$ , the angle becomes more acute and ends up with the deadlock of an edge, Fig. 5(a).

When the matrix  $\mathbf{D}$  approaches the threshold  $4\beta_*^2 = (\text{tr} \mathbf{D})^2$ , two smooth parts of the stability boundary corresponding to negative and positive  $\nu$  come towards each other until they touch, when  $\mathbf{D}$  is at the threshold. After  $\mathbf{D}$  becomes strongly indefinite this temporary glued configuration collapses into two pockets of asymptotic stability, as shown in Fig. 5(b). Each of the two pockets has a deadlock of an edge as well as two edges which meet at the origin and form a singularity known as the “break of an edge” [17].

The configuration of the asymptotic stability domain, shown in Fig. 5(c), corresponds to an indefinite matrix  $\mathbf{K}$  with  $\text{tr} \mathbf{K} > 0$  and  $\det \mathbf{K} < 0$ . In this case

the condition  $\nu^2 > \nu_d^2$  divides the domain of asymptotic stability into two parts, corresponding to positive and negative  $\nu$ . The intervals of  $\nu$ -axis form edges of dihedral angles, which end up with the deadlocks at  $\nu = \pm\nu_f$  and with the trihedral angles at  $\nu = \pm\nu_d$ , Fig. 5(c). Qualitatively, this configuration does not depend on the properties of the matrix  $\mathbf{D}$ .

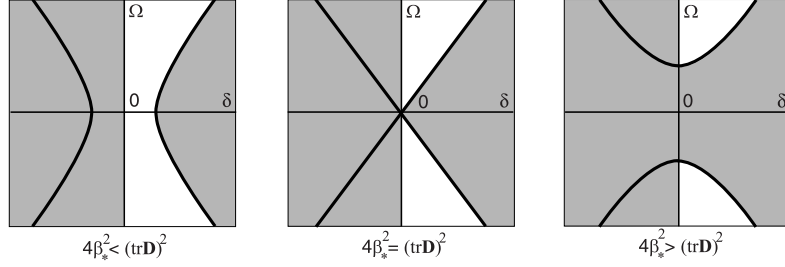

**Fig. 6.** Bifurcation of the domain of the asymptotic stability (white) in the plane  $(\delta, \Omega)$  at  $\nu = 0$  due to the change of the structure of the matrix  $\mathbf{D}$  according to the criterion (44).

We note that the parameter  $4\beta_*^2 - (\text{tr}\mathbf{D})^2$  governs not only the bifurcation of the stability domain near the  $\nu$ -axis, but also the bifurcation of the whole stability domain in the space of the parameters  $\delta$ ,  $\Omega$ , and  $\nu$ . This is seen from the stability conditions (24)–(26). For example, for  $\nu = 0$  the inequality  $Q > 0$  is reduced to  $c(\delta, \Omega) > 0$ , where  $c(\delta, \Omega)$  is given by (26). For positive semi-definite matrices  $\mathbf{D}$  this condition is always satisfied. For indefinite matrices equation  $c(\delta, \Omega) = 0$  defines either hyperbola or two intersecting lines. In case of weakly-indefinite  $\mathbf{D}$  the stability domain is bounded by the  $\nu$ -axis and one of the hyperbolic branches, see Figure 6 (left). At the threshold  $4\beta_*^2 = (\text{tr}\mathbf{D})^2$  the stability domain is separated to two half-conical parts, as shown in the center of Figure 6. Strongly-indefinite damping makes impossible stabilization by small gyroscopic forces, see Figure 6 (right). In this case the non-conservative forces are required for stabilization. Thus, we generalize the results of the works [35, 36], which were obtained for diagonal matrices  $\mathbf{K}$  and  $\mathbf{D}$ . Moreover, the authors of the works [35, 36] did not take into account the non-conservative positional forces corresponding to the matrix  $\mathbf{N}$  in equation (1) and missed the existence of the two classes of indefinite matrices, which lead to the bifurcation of the domain of asymptotic stability. We can also conclude that at least in two dimensions the requirement of definiteness of the matrix  $\mathbf{D}$  established in [46] is not necessary for the stabilization of a circulatory system by gyroscopic and damping forces.

### 3 A gyroscopic system with weak damping and circulatory forces

A statically unstable potential system, which has been stabilized by gyroscopic forces can be destabilized by the introduction of small stationary damping, which is a velocity-dependent force [1]. However, many statically unstable gyropendulums enjoy robust stability at high speeds [31]. To explain this phenomenon a concept of rotating damping has been introduced, which is also proportional to the displacements by a non-conservative way and thus contributes not only to the matrix  $\mathbf{D}$  in equation (1), but to the matrix  $\mathbf{N}$  as well [3–5, 31]. This leads to a problem of perturbation of gyroscopic system (3) by weak dissipative and non-conservative positional forces [14, 27, 31, 32, 46, 48, 49, 59, 62, 63, 66, 74].

#### 3.1 Stability of a gyroscopic system

In the absence of dissipative and circulatory forces ( $\delta = \nu = 0$ ), the polynomial (10) has four roots  $\pm\lambda_{\pm}$ , where

$$\lambda_{\pm} = \sqrt{-\frac{1}{2}(\text{tr}\mathbf{K} + \Omega^2) \pm \frac{1}{2}\sqrt{(\text{tr}\mathbf{K} + \Omega^2)^2 - 4\det\mathbf{K}}}. \quad (51)$$

Analysis of these eigenvalues yields the following result, see e.g. [47].

**Proposition 4.** *If  $\det\mathbf{K} > 0$  and  $\text{tr}\mathbf{K} < 0$ , gyroscopic system (3) with two degrees of freedom is unstable by divergence for  $\Omega^2 < \Omega_0^{-2}$ , unstable by flutter for  $\Omega_0^{-2} \leq \Omega^2 \leq \Omega_0^{+2}$ , and stable for  $\Omega_0^{+2} < \Omega^2$ , where the critical values  $\Omega_0^-$  and  $\Omega_0^+$  are*

$$0 \leq \sqrt{-\text{tr}\mathbf{K} - 2\sqrt{\det\mathbf{K}}} =: \Omega_0^- \leq \Omega_0^+ := \sqrt{-\text{tr}\mathbf{K} + 2\sqrt{\det\mathbf{K}}}. \quad (52)$$

*If  $\det\mathbf{K} > 0$  and  $\text{tr}\mathbf{K} > 0$ , the gyroscopic system is stable for any  $\Omega$  [2].*

*If  $\det\mathbf{K} \leq 0$ , the system is unstable [1].*

Representing for  $\det\mathbf{K} > 0$  the equation (51) in the form

$$\lambda_{\pm} = \sqrt{-\frac{1}{2}\left(\Omega^2 - \frac{1}{2}(\Omega_0^{-2} + \Omega_0^{+2})\right) \pm \frac{1}{2}\sqrt{\left(\Omega^2 - \Omega_0^{-2}\right)\left(\Omega^2 - \Omega_0^{+2}\right)}}. \quad (53)$$

we find that at  $\Omega = 0$  there are in general four real roots  $\pm\lambda_{\pm} = \pm(\Omega_0^+ \pm \Omega_0^-)/2$  and system (3) is statically unstable. With the increase of  $\Omega^2$  the distance  $\lambda_+ - \lambda_-$  between the two roots of the same sign is getting smaller. The roots are moving towards each other until they merge at  $\Omega^2 = \Omega_0^{-2}$  with the origination of a pair of double real eigenvalues  $\pm\omega_0$  with the Jordan blocks, where

$$\omega_0 = \frac{1}{2}\sqrt{\Omega_0^{+2} - \Omega_0^{-2}} = \sqrt[4]{\det\mathbf{K}} > 0. \quad (54)$$

Further increase of  $\Omega^2$  yields splitting of  $\pm\omega_0$  to two couples of complex conjugate eigenvalues lying on the circle

$$\operatorname{Re}\lambda^2 + \operatorname{Im}\lambda^2 = \omega_0^2. \quad (55)$$

The complex eigenvalues move along the circle until at  $\Omega^2 = \Omega_0^{+2}$  they reach the imaginary axis and originate a complex-conjugate pair of double purely imaginary eigenvalues  $\pm i\omega_0$ . For  $\Omega^2 > \Omega_0^{+2}$  the double eigenvalues split into four simple purely imaginary eigenvalues which do not leave the imaginary axis, Fig. 7.

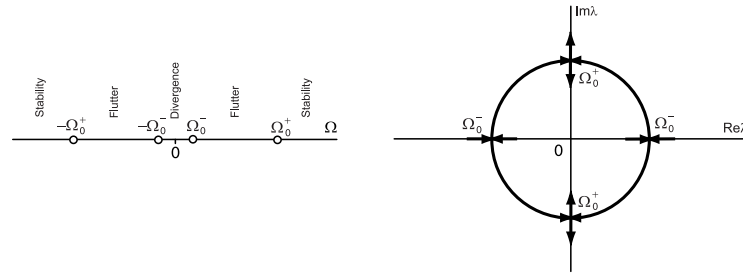

**Fig. 7.** Stability diagram for the gyroscopic system with  $\mathbf{K} < 0$  (left) and the corresponding trajectories of the eigenvalues in the complex plane for the increasing parameter  $\Omega > 0$  (right).

Thus, the system (3) with  $\mathbf{K} < 0$  is statically unstable for  $\Omega \in (-\Omega_0^-, \Omega_0^-)$ , it is dynamically unstable for  $\Omega \in [-\Omega_0^+, -\Omega_0^-] \cup [\Omega_0^-, \Omega_0^+]$ , and it is stable (gyroscopic stabilization) for  $\Omega \in (-\infty, -\Omega_0^+) \cup (\Omega_0^+, \infty)$ , see Fig. 7. The values of the gyroscopic parameter  $\pm\Omega_0^-$  define the boundary between the divergence and flutter domains while the values  $\pm\Omega_0^+$  originate the flutter-stability boundary.

### 3.2 The influence of small damping and non-conservative positional forces on the stability of a gyroscopic system

Consider the asymptotic stability domain in the plane  $(\delta, \nu)$  in the vicinity of the origin, assuming that  $\Omega \neq 0$  is fixed. Observing that the third of the inequalities (22) is fulfilled for  $\det \mathbf{K} > 0$  and the first one simply restricts the region of variation of  $\delta$  to the half-plane  $\delta \operatorname{tr} \mathbf{D} > 0$ , we focus our analysis on the remaining two of the conditions (22).

Taking into account the structure of coefficients (26) and leaving the linear terms with respect to  $\delta$  in the Taylor expansions of the functions  $\nu_{cr}^\pm(\delta, \Omega)$ , we

get the equations determining a linear approximation to the stability boundary

$$\begin{aligned} \nu &= \frac{\text{tr}\mathbf{K}\mathbf{D} - \text{tr}\mathbf{K}\text{tr}\mathbf{D} - \text{tr}\mathbf{D}\lambda_{\pm}^2(\Omega)}{2\Omega} \delta \\ &= \frac{2\text{tr}\mathbf{K}\mathbf{D} + \text{tr}\mathbf{D}(\Omega^2 - \text{tr}\mathbf{K}) \pm \text{tr}\mathbf{D}\sqrt{(\Omega^2 + \text{tr}\mathbf{K})^2 - 4\det\mathbf{K}}}{4\Omega} \delta, \end{aligned} \quad (56)$$

where the eigenvalues  $\lambda_{\pm}(\Omega)$  are given by formula (51).

For  $\det\mathbf{K} > 0$  and  $\text{tr}\mathbf{K} > 0$  the gyroscopic system is stable at any  $\Omega$ . Consequently, the coefficients  $\lambda_{\pm}^2(\Omega)$  are always real, and equations (56) define in general two lines intersecting at the origin, Fig. 8. Since  $\text{tr}\mathbf{K} > 0$ , the second of the inequalities (22) is satisfied for  $\det\mathbf{D} \geq 0$ , and it gives an upper bound of  $\delta^2$  for  $\det\mathbf{D} < 0$ . Thus, a linear approximation to the domain of asymptotic stability near the origin in the plane  $(\delta, \nu)$ , is an angle-shaped area between two lines (56), as shown in Fig. 8. With the change of  $\Omega$  the size of the angle is varying and moreover, the stability domain rotates as a whole about the origin. As  $\Omega \rightarrow \infty$ , the size of the angle tends to  $\pi/2$  in such a way that the stability domain fits one of the four quadrants of the parameter plane, as shown in Fig. 8 (right column). From (56) it follows that asymptotically as  $\Omega \rightarrow 0$

$$\nu(\Omega) = \frac{\nu_f}{\Omega} \left( \beta_* \pm \frac{\text{tr}\mathbf{D}}{2} \right) + o\left(\frac{1}{\Omega}\right). \quad (57)$$

Consequently, the angle between the lines (56) tends to  $\pi$  for the matrices  $\mathbf{D}$  satisfying the condition  $4\beta_*^2 < (\text{tr}\mathbf{D})^2$ , see Fig. 8 (upper left). In this case in the linear approximation the domain of asymptotic stability spreads over two quadrants and contains the  $\delta$ -axis. Otherwise, the angle tends to zero as  $\Omega \rightarrow 0$ , Fig. 8 (lower left). In the linear approximation the stability domain always belongs to one quadrant and does not contain  $\delta$ -axis, so that in the absence of non-conservative positional forces gyroscopic system (3) with  $\mathbf{K} > 0$  cannot be made asymptotically stable by damping forces with strongly-indefinite matrix  $\mathbf{D}$ , which is also visible in the three-dimensional picture of Fig. 5(b). The three-dimensional domain of asymptotic stability of near-Hamiltonian system (1) with  $\mathbf{K} > 0$  and  $\mathbf{D}$  semi-definite or weakly-indefinite is inside a dihedral angle with the  $\Omega$ -axis as its edge, as shown in Fig. 5(a). With the increase in  $|\Omega|$ , the section of the domain by the plane  $\Omega = \text{const}$  is getting more narrow and is rotating about the origin so that the points of the parameter plane  $(\delta, \nu)$  that were stable at lower  $|\Omega|$  can lose their stability for the higher absolute values of the gyroscopic parameter (*gyroscopic destabilization* of a statically stable potential system in the presence of damping and non-conservative positional forces).

To study the case when  $\mathbf{K} < 0$  we write equation (56) in the form

$$\nu = \frac{\Omega_0^+}{\Omega} \left[ \gamma_* + \frac{\text{tr}\mathbf{D}}{4} \sqrt{\frac{\Omega^2}{\Omega_0^{+2}} - 1} \left( \sqrt{\Omega^2 - \Omega_0^{+2}} \pm \sqrt{\Omega^2 - \Omega_0^{-2}} \right) \right] \delta, \quad (58)$$

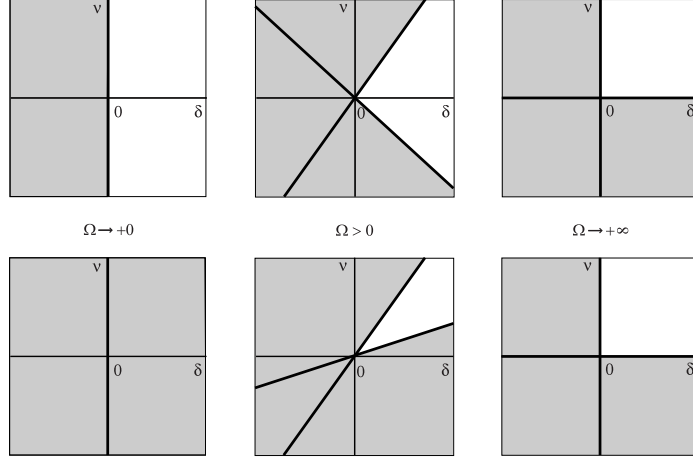

**Fig. 8.** For various  $\Omega$ , bold lines show linear approximations to the boundary of the asymptotic stability domain (white) of system (1) in the vicinity of the origin in the plane  $(\delta, \nu)$ , when  $\text{tr} \mathbf{K} > 0$  and  $\det \mathbf{K} > 0$ , and  $4\beta_*^2 < (\text{tr} \mathbf{D})^2$  (upper row) or  $4\beta_*^2 > (\text{tr} \mathbf{D})^2$  (lower row).

where

$$\gamma_* := \frac{\text{tr}[\mathbf{K} + (\Omega_0^{+2} - \omega_0^2)\mathbf{I}]\mathbf{D}}{2\Omega_0^+}. \quad (59)$$

**Proposition 5.** Let  $\lambda_1(\mathbf{D})$  and  $\lambda_2(\mathbf{D})$  be eigenvalues of  $\mathbf{D}$ . Then,

$$|\gamma_*| \leq \Omega_0^+ \frac{|\lambda_1(\mathbf{D}) + \lambda_2(\mathbf{D})|}{4} + \Omega_0^- \frac{|\lambda_1(\mathbf{D}) - \lambda_2(\mathbf{D})|}{4}. \quad (60)$$

*Proof.* With the use of the Cauchy-Schwarz inequality we obtain

$$\begin{aligned} |\gamma_*| &\leq \Omega_0^+ \frac{|\text{tr} \mathbf{D}|}{4} + \frac{\text{tr}(\mathbf{K} - \frac{\text{tr} \mathbf{K}}{2}\mathbf{I})(\mathbf{D} - \frac{\text{tr} \mathbf{D}}{2}\mathbf{I})}{2\Omega_0^+} \\ &\leq \Omega_0^+ \frac{|\text{tr} \mathbf{D}|}{4} + \frac{|\lambda_1(\mathbf{K}) - \lambda_2(\mathbf{K})||\lambda_1(\mathbf{D}) - \lambda_2(\mathbf{D})|}{4\Omega_0^+}. \end{aligned} \quad (61)$$

Taking into account that  $|\lambda_1(\mathbf{K}) - \lambda_2(\mathbf{K})| = \Omega_0^- \Omega_0^+$ , we get inequality (60).

Expression (58) is real-valued when  $\Omega^2 \geq \Omega_0^{+2}$  or  $\Omega^2 \leq \Omega_0^{-2}$ . For sufficiently small  $|\delta|$  the first inequality implies the second of the stability conditions (22), whereas the last inequality contradicts it. Consequently, the domain of asymptotic stability is determined by the inequalities  $\delta \text{tr} \mathbf{D} > 0$  and  $Q(\delta, \nu, \Omega) > 0$ , and its linear approximation in the vicinity of the origin in the  $(\delta, \nu)$ -plane has the form of an angle with the boundaries given by equations (58). For  $\Omega$  tending to infinity the angle expands to  $\pi/2$ , whereas for  $\Omega = \Omega_0^+$  or  $\Omega = -\Omega_0^+$

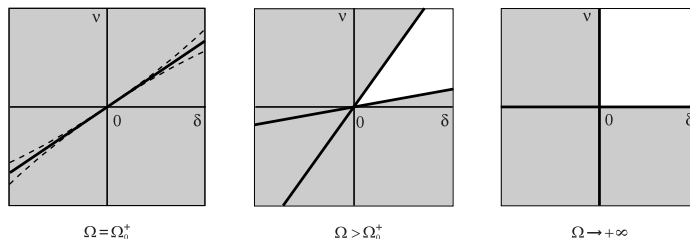

**Fig. 9.** For various  $\Omega$ , bold lines show linear approximations to the boundary of the asymptotic stability domain (white) of system (1) in the vicinity of the origin in the plane  $(\delta, \nu)$ , when  $\mathbf{K} < 0$ .

it degenerates to a single line  $\nu = \delta\gamma_*$  or  $\nu = -\delta\gamma_*$  respectively. For  $\gamma_* \neq 0$  these lines are not parallel to each other, and due to inequality (60) they never stay vertical, see Fig. 9 (left). The degeneration can, however, be removed in the second-order approximation in  $\delta$

$$\nu = \pm\delta\gamma_* \pm \frac{\text{tr}\mathbf{D}\sqrt{\omega_0^2 \det \mathbf{D} - \gamma_*^2}}{2\Omega_0^+} \delta^2 + O(\delta^3), \quad (62)$$

as shown by dashed lines in Fig. 9 (left). Therefore, gyroscopic stabilization of statically unstable conservative system with  $\mathbf{K} < 0$  can be improved up to asymptotic stability by small damping and circulatory forces, if their magnitudes are in the narrow region with the boundaries depending on  $\Omega$ . The lower the desirable absolute value of the critical gyroscopic parameter  $\Omega_{\text{cr}}(\delta, \nu)$  the poorer choice of the appropriate combinations of damping and circulatory forces.

To estimate the new critical value of the gyroscopic parameter  $\Omega_{\text{cr}}(\delta, \nu)$ , which can deviate significantly from that of the conservative gyroscopic system, we consider the formula (58) in the vicinity of the points  $(0, 0, \pm\Omega_0^+)$  in the parameter space. Leaving only the terms, which are constant or proportional to  $\sqrt{\Omega \pm \Omega_0^+}$  in both the numerator and denominator and assuming  $\nu = \gamma\delta$ , we find

$$\pm\Omega_{\text{cr}}^+(\gamma) = \pm\Omega_0^+ \pm \Omega_0^+ \frac{2}{(\omega_0 \text{tr}\mathbf{D})^2} (\gamma \mp \gamma_*)^2 + o((\gamma - \gamma_*)^2), \quad (63)$$

After substitution  $\gamma = \nu/\delta$  equations (63) take the form canonical for the Whitney umbrella. The domain of asymptotic stability consists of two pockets of two Whitney umbrellas, selected by the conditions  $\delta \text{tr}\mathbf{D} > 0$  and  $Q(\delta, \nu, \Omega) > 0$ . Equations (58) are a linear approximation to the stability boundary in the vicinity of the  $\Omega$ -axis. Moreover, they describe in an implicit form a limit of the critical gyroscopic parameter  $\Omega_{\text{cr}}(\delta, \gamma\delta)$  when  $\delta$  tends to zero, as a function of the ratio  $\gamma = \nu/\delta$ , Fig. 10(b). Most of the directions  $\gamma$  give the limit value  $|\Omega_{\text{cr}}^\pm(\gamma)| > \Omega_0^+$  with an exception for  $\gamma = \gamma_*$  and  $\gamma = -\gamma_*$ , so that



$\Omega_{\text{cr}}^+(\gamma_*) = \Omega_0^+$  and  $\Omega_{\text{cr}}^-(-\gamma_*) = -\Omega_0^+$ . Estimates of the critical gyroscopic parameter (63) are extended to the case of arbitrary number of degrees of freedom by the following statement.

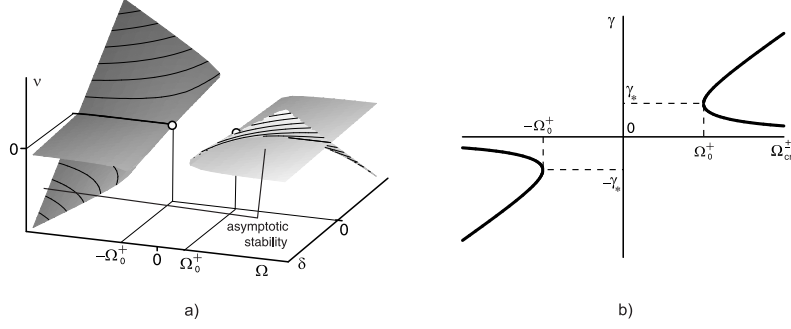

**Fig. 10.** Blowing the domain of gyroscopic stabilization of a statically unstable conservative system with  $\mathbf{K} < 0$  up to the domain of asymptotic stability with the Whitney umbrella singularities (a). The limits of the critical gyroscopic parameter  $\Omega_{\text{cr}}^\pm$  as functions of  $\gamma = \nu/\delta$  (b).

**Theorem 2.** *Let the system (3) with even number  $m$  of degrees of freedom be gyroscopically stabilized for  $\Omega > \Omega_0^+$  and let at  $\Omega = \Omega_0^+$  its spectrum contain a double eigenvalue  $i\omega_0$  with the Jordan chain of generalized eigenvectors  $\mathbf{u}_0, \mathbf{u}_1$ , satisfying the equations*

$$\begin{aligned} (-\mathbf{I}\omega_0^2 + i\omega_0\Omega_0^+\mathbf{G} + \mathbf{K})\mathbf{u}_0 &= 0, \\ (-\mathbf{I}\omega_0^2 + i\omega_0\Omega_0^+\mathbf{G} + \mathbf{K})\mathbf{u}_1 &= -(2i\omega_0\mathbf{I} + \Omega_0^+\mathbf{G})\mathbf{u}_0. \end{aligned} \quad (64)$$

Define the real quantities  $d_1, d_2, n_1, n_2$ , and  $\gamma_*$  as

$$\begin{aligned} d_1 &= \text{Re}(\bar{\mathbf{u}}_0^T \mathbf{D}\mathbf{u}_0), & d_2 &= \text{Im}(\bar{\mathbf{u}}_0^T \mathbf{D}\mathbf{u}_1 - \bar{\mathbf{u}}_1^T \mathbf{D}\mathbf{u}_0), \\ n_1 &= \text{Im}(\bar{\mathbf{u}}_0^T \mathbf{N}\mathbf{u}_0), & n_2 &= \text{Re}(\bar{\mathbf{u}}_0^T \mathbf{N}\mathbf{u}_1 - \bar{\mathbf{u}}_1^T \mathbf{N}\mathbf{u}_0), \end{aligned} \quad (65)$$

$$\gamma_* = -i\omega_0 \frac{\bar{\mathbf{u}}_0^T \mathbf{D}\mathbf{u}_0}{\bar{\mathbf{u}}_0^T \mathbf{N}\mathbf{u}_0}, \quad (66)$$

where the bar over a symbol denotes complex conjugate.

Then, in the vicinity of  $\gamma := \nu/\delta = \gamma_*$  the limit of the critical value of the gyroscopic parameter  $\Omega_{\text{cr}}^+$  of the near-Hamiltonian system as  $\delta \rightarrow 0$  is

$$\Omega_{\text{cr}}^+(\gamma) = \Omega_0^+ + \frac{n_1^2(\gamma - \gamma_*)^2}{\mu^2(\omega_0 d_2 - \gamma_* n_2 - d_1)^2}, \quad (67)$$

which is valid for  $|\gamma - \gamma_*| \ll 1$ .

*Proof.* Perturbing the system (3), which is stabilized by the gyroscopic forces with  $\Omega > \Omega_0^+$ , by small damping and circulatory forces, yields an increment to a simple eigenvalue [53]

$$\lambda = i\omega - \frac{\omega^2 \bar{\mathbf{u}}^T \mathbf{D} \mathbf{u} \delta - i\omega \bar{\mathbf{u}}^T \mathbf{N} \mathbf{u} \nu}{\bar{\mathbf{u}}^T \mathbf{K} \mathbf{u} + \omega^2 \bar{\mathbf{u}}^T \mathbf{u}} + o(\delta, \nu). \quad (68)$$

Choose the eigenvalues and the corresponding eigenvectors that merge at  $\Omega = \Omega_0^+$

$$\begin{aligned} i\omega(\Omega) &= i\omega_0 \pm i\mu \sqrt{\Omega - \Omega_0^+} + o(|\Omega - \Omega_0^+|^{\frac{1}{2}}), \\ \mathbf{u}(\Omega) &= \mathbf{u}_0 \pm i\mu \mathbf{u}_1 \sqrt{\Omega - \Omega_0^+} + o(|\Omega - \Omega_0^+|^{\frac{1}{2}}), \end{aligned} \quad (69)$$

where

$$\mu^2 = -\frac{2\omega_0^2 \bar{\mathbf{u}}_0^T \mathbf{u}_0}{\Omega_0^+ (\omega_0^2 \bar{\mathbf{u}}_1^T \mathbf{u}_1 - \bar{\mathbf{u}}_1^T \mathbf{K} \mathbf{u}_1 - i\omega_0 \Omega_0^+ \bar{\mathbf{u}}_1^T \mathbf{G} \mathbf{u}_1 - \bar{\mathbf{u}}_0^T \mathbf{u}_0)}. \quad (70)$$

Since  $\mathbf{D}$  and  $\mathbf{K}$  are real symmetric matrices and  $\mathbf{N}$  is a real skew-symmetric one, the first-order increment to the eigenvalue  $i\omega(\Omega)$  given by (68) is real-valued. Consequently, in the first approximation in  $\delta$  and  $\nu$ , simple eigenvalue  $i\omega(\Omega)$  remains on the imaginary axis, if  $\nu = \gamma(\Omega)\delta$ , where

$$\gamma(\Omega) = -i\omega(\Omega) \frac{\bar{\mathbf{u}}^T(\Omega) \mathbf{D} \mathbf{u}(\Omega)}{\bar{\mathbf{u}}^T(\Omega) \mathbf{N} \mathbf{u}(\Omega)}. \quad (71)$$

Substitution of the expansions (69) into the formula (71) yields

$$\gamma(\Omega) = -(\omega_0 \pm \mu \sqrt{\Omega - \Omega_0^+}) \frac{d_1 \mp \mu d_2 \sqrt{\Omega - \Omega_0^+}}{n_1 \pm \mu n_2 \sqrt{\Omega - \Omega_0^+}}, \quad (72)$$

wherefrom the expression (67) follows, if  $|\gamma - \gamma_*| \ll 1$ .

Substituting  $\gamma = \nu/\delta$  in expression (72) yields the estimate for the critical value of the gyroscopic parameter  $\Omega_{\text{cr}}^+(\delta, \nu)$

$$\Omega_{\text{cr}}^+(\delta, \nu) = \Omega_0^+ + \frac{n_1^2 (\nu - \gamma_* \delta)^2}{\mu^2 (\omega_0 d_2 - \gamma_* n_2 - d_1)^2 \delta^2}. \quad (73)$$

We show now that for  $m = 2$  expression (67) implies (63). At the critical value of the gyroscopic parameter  $\Omega_0^+$  defined by equation (52), the double eigenvalue  $i\omega_0$  with  $\omega_0$  given by (54) has the Jordan chain

$$\mathbf{u}_0 = \begin{bmatrix} -i\omega_0 \Omega_0^+ - k_{12} \\ -\omega_0^2 + k_{11} \end{bmatrix}, \quad \mathbf{u}_1 = \frac{-1}{\omega_0^2 - k_{22}} \begin{bmatrix} 0 \\ i\omega_0 (k_{22} - k_{11}) - \Omega_0^+ k_{12} \end{bmatrix}. \quad (74)$$

With the vectors (74) equation (70) yields

$$\mu^2 = \frac{\Omega_0^+}{2} \frac{(\omega_0^2 - k_{11})(\omega_0^2 - k_{22})}{\Omega_0^{+2} \omega_0^2 - k_{12}^2} = \frac{\Omega_0^+}{2} > 0, \quad (75)$$

whereas the formula (66) reproduces the coefficient  $\gamma_*$  given by (59). To show that (63) follows from (67) it remains to calculate the coefficients (65). We have

$$\mathbf{n}_1 = -2\Omega_0^+ \omega_0 (\omega_0^2 - k_{11}), \quad \omega_0 \mathbf{d}_2 - \gamma_* \mathbf{n}_2 - \mathbf{d}_1 = -2\omega_0^2 (\omega_0^2 - k_{11}) \text{tr} \mathbf{D}. \quad (76)$$

Taking into account that  $(\Omega_0^+)^2 = -\text{tr} \mathbf{K} + 2\omega_0^2$ , and using the relations (76) in (73) we exactly reproduce (63).

Therefore, in the presence of small damping and non-conservative positional forces, gyroscopic forces can both destabilize a statically stable conservative system (gyroscopic destabilization) and stabilize a statically unstable conservative system (gyroscopic stabilization). The first effect is essentially related with the dihedral angle singularity of the stability boundary, whereas the second one is governed by the Whitney umbrella singularity. In the remaining sections we demonstrate how these singularities appear in mechanical systems.

#### 4 The modified Maxwell-Bloch equations with mechanical applications

The modified Maxwell-Bloch equations are the normal form for rotationally symmetric, planar dynamical systems [28, 48, 59]. They follow from equation (1) for  $m = 2$ ,  $\mathbf{D} = \mathbf{I}$ , and  $\mathbf{K} = \kappa \mathbf{I}$ , and thus can be written as a single differential equation with the complex coefficients

$$\ddot{x} + i\Omega \dot{x} + \delta \dot{x} + i\nu x + \kappa x = 0, \quad x = x_1 - ix_2, \quad (77)$$

where  $\kappa$  corresponds to potential forces. Equations in this form appear in gyro-dynamical problems such as the tippe top inversion, the rising egg, and the onset of oscillations in the squealing disc brake and the singing wine glass [14, 31, 48, 59, 62, 66, 68, 76].

According to stability conditions (22) the solution  $x = 0$  of equation (77) is asymptotically stable if and only if

$$\delta > 0, \quad \Omega > \frac{\nu}{\delta} - \frac{\delta}{\nu} \kappa. \quad (78)$$

For  $\kappa > 0$  the domain of asymptotic stability is a dihedral angle with the  $\Omega$ -axis serving as its edge, Fig. 11(a). The sections of the domain by the planes  $\Omega = \text{const}$  are contained in the angle-shaped regions with the boundaries

$$\nu = \frac{\Omega \pm \sqrt{\Omega^2 + 4\kappa}}{2} \delta. \quad (79)$$

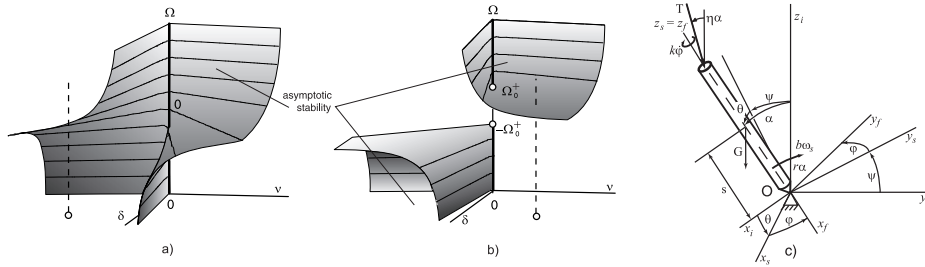

**Fig. 11.** Two configurations of the asymptotic stability domain of the modified Maxwell-Bloch equations for  $\kappa > 0$  (a) and  $\kappa < 0$  (b) corresponding to *gyroscopic destabilization* and *gyroscopic stabilization* respectively; Hauger's gyropendulum (c).

The domain shown in Fig. 11(a) is a particular case of that depicted in Fig. 5(a). For  $\mathbf{K} = \kappa \mathbf{I}$  the interval  $[-v_f, v_f]$  shown in Fig. 5(a) shrinks to a point so that at  $\Omega = 0$  the angle is bounded by the lines  $v = \pm \delta \sqrt{\kappa}$  and thus it is less than  $\pi$ . The domain of asymptotic stability is twisting around the  $\Omega$ -axis in such a manner that it always remains in the half-space  $\delta > 0$ , Fig. 11(a). Consequently, the system stable at  $\Omega = 0$  can become unstable at greater  $\Omega$ , as shown in Fig. 11(a) by the dashed line. The larger magnitudes of circulatory forces, the lower  $|\Omega|$  at the onset of instability.

As  $\kappa > 0$  decreases, the hypersurfaces forming the dihedral angle approach each other so that, at  $\kappa = 0$ , they temporarily merge along the line  $v = 0$  and a new configuration originates for  $\kappa < 0$ , Fig. 11(b). The new domain of asymptotic stability consists of two disjoint parts that are pockets of two Whitney umbrellas singled out by inequality  $\delta > 0$ . The absolute values of the gyroscopic parameter  $\Omega$  in the stability domain are always not less than  $\Omega_0^+ = 2\sqrt{-\kappa}$ . As a consequence, the system unstable at  $\Omega = 0$  can become asymptotically stable at greater  $\Omega$ , as shown in Fig. 11(b) by the dashed line.

#### 4.1 Stability of Hauger's gyropendulum

Hauger's gyropendulum [14] is an axisymmetric rigid body of mass  $m$  hinged at the point  $O$  on the axis of symmetry as shown in Figure (11)(c). The body's moment of inertia about the axis through the point  $O$  perpendicular to the axis of symmetry is denoted by  $I$ , the body's moment of inertia about the axis of symmetry is denoted by  $I_0$ , and the distance between the fastening point and the center of mass is  $s$ . The orientation of the pendulum, which is associated with the trihedron  $Ox_f y_f z_f$ , with respect to the fixed trihedron  $Ox_i y_i z_i$  is specified by the angles  $\psi$ ,  $\theta$ , and  $\phi$ . The pendulum experiences the force of gravity  $G = mg$  and a follower torque  $T$  that lies in the plane of the  $z_i$  and  $z_f$  coordinate axes. The moment vector makes an angle of  $\eta\alpha$  with the axis  $z_i$ , where  $\eta$  is a

parameter ( $\eta \neq 1$ ) and  $\alpha$  is the angle between the  $z_i$  and  $z_f$  axes. Additionally, the pendulum experiences the restoring elastic moment  $R = -r\alpha$  in the hinge and the dissipative moments  $B = -b\omega_s$  and  $K = -k\phi$ , where  $\omega_s$  is the angular velocity of an auxiliary coordinate system  $Ox_s y_s z_s$  with respect to the inertial system and  $r$ ,  $b$ , and  $k$  are the corresponding coefficients.

Linearization of the nonlinear equations of motion derived in [14] with the new variables  $x_1 = \psi$  and  $x_2 = \theta$  and the subsequent nondimensionalization yield the Maxwell-Bloch equations (77) where the dimensionless parameters are given by

$$\Omega = \frac{I_0}{I}, \quad \delta = \frac{b}{I\omega}, \quad \kappa = \frac{r - mgs}{I\omega^2}, \quad \nu = \frac{1 - \eta}{I\omega^2} T, \quad \omega = -\frac{T}{k}. \quad (80)$$

The domain of asymptotic stability of the Hauger gyropendulum, given by (78), is shown in Fig. 11(a,b).

According to formulas (52) and (54), for the statically unstable gyropendulum ( $\kappa < 0$ ) the singular points on the  $\Omega$ -axis correspond to the critical values  $\pm\Omega_0^+ = \pm 2\sqrt{-\kappa}$  and the critical frequency  $\omega_0 = \sqrt{-\kappa}$ . Noting that  $\Omega_{cr}^+(\nu = \pm\sqrt{-\kappa}\delta, \delta) = \pm\Omega_0^+$  and substituting  $\gamma = \nu/\delta$  into formula (78), we expand  $\Omega_{cr}^+(\gamma)$  in a series in the neighborhood of  $\gamma = \pm\sqrt{-\kappa}$

$$\Omega_{cr}^+(\gamma) = \pm 2\sqrt{-\kappa} \pm \frac{1}{\sqrt{-\kappa}} (\gamma \mp \sqrt{-\kappa})^2 + o((\gamma \mp \sqrt{-\kappa})^2). \quad (81)$$

Proceeding from  $\gamma$  to  $\nu$  and  $\delta$  in (81) yields approximations of the stability boundary near the singularities:

$$\Omega_{cr}^+(\nu, \delta) = \pm 2\sqrt{-\kappa} \pm \frac{1}{\sqrt{-\kappa}} \frac{(\nu \mp \delta\sqrt{-\kappa})^2}{\delta^2}. \quad (82)$$

They also follow from formula (63) after substituting  $\omega_0 = \sqrt{-\kappa}$ , and  $\gamma_* = \sqrt{-\kappa}$ , where the last value is given by (59). Thus, Hauger's gyropendulum, which is unstable at  $\Omega = 0$ , can become asymptotically stable for sufficiently large  $|\Omega| \geq \Omega_0^+$  under a suitable combination of dissipative and nonconservative positional forces. Note that Hauger failed to find Whitney umbrella singularities on the boundary of the pendulum's gyroscopic stabilization domain.

## 4.2 Friction-induced instabilities in rotating elastic bodies of revolution

The modified Maxwell-Bloch equations (77) with  $\Omega = 2\tilde{\Omega}$ ,  $\kappa = \rho^2 - \tilde{\Omega}^2$ , and  $\nu = 0$  and  $\delta = 0$ , where  $\rho > 0$  is the frequency of free vibrations of the potential system corresponding to  $\delta = \tilde{\Omega} = \nu = 0$ , describe a two-mode approximation of the models of rotating elastic bodies of revolution after their linearization and discretization [67, 71, 76]. In the absence of dissipative and non-conservative

positional forces the characteristic polynomial (10) corresponding to the operator  $\mathbf{L}_0(\tilde{\Omega}) = \mathbf{I}\lambda^2 + 2\lambda\tilde{\Omega}\mathbf{G} + (\rho^2 - \tilde{\Omega}^2)\mathbf{I}$ , which belongs to the class of matrix polynomials considered, e.g., in [38], has four purely imaginary roots

$$\lambda_p^\pm = i\rho \pm i\tilde{\Omega}, \quad \lambda_n^\pm = -i\rho \pm i\tilde{\Omega}. \quad (83)$$

In the plane  $(\tilde{\Omega}, \text{Im } \lambda)$  the eigenvalues (83) form a collection of straight lines intersecting with each other – *the spectral mesh* [64, 76]. Two nodes of the mesh at  $\tilde{\Omega} = 0$  correspond to the double semi-simple eigenvalues  $\lambda = \pm i\rho$ . The double semi-simple eigenvalue  $i\rho$  at  $\tilde{\Omega} = \tilde{\Omega}_0 = 0$  has two linearly-independent eigenvectors  $\mathbf{u}_1$  and  $\mathbf{u}_2$

$$\mathbf{u}_1 = \frac{1}{\sqrt{2\rho}} \begin{pmatrix} 0 \\ 1 \end{pmatrix}, \quad \mathbf{u}_2 = \frac{1}{\sqrt{2\rho}} \begin{pmatrix} 1 \\ 0 \end{pmatrix}. \quad (84)$$

The eigenvectors are orthogonal  $\mathbf{u}_i^\top \mathbf{u}_j = 0$ ,  $i \neq j$ , and satisfy the normalization condition  $\mathbf{u}_i^\top \mathbf{u}_i = (2\rho)^{-1}$ . At the other two nodes at  $\tilde{\Omega} = \pm\tilde{\Omega}_d$  there exist double semi-simple eigenvalues  $\lambda = 0$ . The range  $|\tilde{\Omega}| < \tilde{\Omega}_d = \rho$  is called *subcritical* for the gyroscopic parameter  $\tilde{\Omega}$ .

In the following, with the use of the perturbation theory of multiple eigenvalues, we describe the deformation of the mesh caused by dissipative ( $\delta\mathbf{D}$ ) and non-conservative perturbations ( $\nu\mathbf{N}$ ), originating, e.g. from the frictional contact, and clarify the key role of indefinite damping and non-conservative positional forces in the development of the subcritical flutter instability. This will give a clear mathematical description of the mechanism of excitation of particular modes of rotating structures in frictional contact, such as squealing disc brakes and singing wine glasses [67, 71, 76].

Under perturbation of the gyroscopic parameter  $\tilde{\Omega} = \tilde{\Omega}_0 + \Delta\tilde{\Omega}$ , the double eigenvalue  $i\rho$  into two simple ones bifurcates according to the asymptotic formula [58]

$$\lambda_p^\pm = i\rho + i\Delta\tilde{\Omega} \frac{f_{11} + f_{22}}{2} \pm i\Delta\tilde{\Omega} \sqrt{\frac{(f_{11} - f_{22})^2}{4} + f_{12}f_{21}} \quad (85)$$

where the quantities  $f_{ij}$  are

$$f_{ij} = \mathbf{u}_j^\top \frac{\partial \mathbf{L}_0(\tilde{\Omega})}{\partial \tilde{\Omega}} \mathbf{u}_i \Big|_{\tilde{\Omega}=0, \lambda=i\rho} = 2i\rho \mathbf{u}_j^\top \mathbf{G} \mathbf{u}_i. \quad (86)$$

The skew symmetry of  $\mathbf{G}$  yields  $f_{11} = f_{22} = 0$ ,  $f_{12} = -f_{21} = i$ , so that (86) gives the exact result (83).

**4.2.1 Deformation of the spectral mesh.** Consider a perturbation of the gyroscopic system  $\mathbf{L}_0(\tilde{\Omega}) + \Delta\mathbf{L}(\tilde{\Omega})$ , assuming that the size of the perturbation  $\Delta\mathbf{L}(\tilde{\Omega}) = \delta\lambda\mathbf{D} + \nu\mathbf{N} \sim \varepsilon$  is small, where  $\varepsilon = \|\Delta\mathbf{L}(0)\|$  is the Frobenius norm

of the perturbation at  $\tilde{\Omega} = 0$ . The behavior of the perturbed eigenvalue  $i\rho$  for small  $\tilde{\Omega}$  and small  $\varepsilon$  is described by the asymptotic formula [58]

$$\lambda = i\beta + i\tilde{\Omega}\frac{(f_{11} + f_{22})}{2} + i\frac{\varepsilon_{11} + \varepsilon_{22}}{2} \pm i\sqrt{\frac{(\tilde{\Omega}(f_{11} - f_{22}) + \varepsilon_{11} - \varepsilon_{22})^2}{4} + (\tilde{\Omega}f_{12} + \varepsilon_{12})(\tilde{\Omega}f_{21} + \varepsilon_{21})}, \quad (87)$$

where  $f_{ij}$  are given by (86) and  $\varepsilon_{ij}$  are small complex numbers of order  $\varepsilon$

$$\varepsilon_{ij} = \mathbf{u}_j^T \Delta \mathbf{L}(0) \mathbf{u}_i = i\rho \delta \mathbf{u}_j^T \mathbf{D} \mathbf{u}_i + \nu \mathbf{u}_j^T \mathbf{N} \mathbf{u}_i. \quad (88)$$

With the use of the vectors (84) we obtain

$$\lambda = i\rho - \frac{\mu_1 + \mu_2}{4} \delta \pm \sqrt{c}, \quad c = \left( \frac{\mu_1 - \mu_2}{4} \right)^2 \delta^2 + \left( i\tilde{\Omega} + \frac{\nu}{2\rho} \right)^2, \quad (89)$$

where the eigenvalues  $\mu_1, \mu_2$  of  $\mathbf{D}$  satisfy the equation  $\mu^2 - \mu \text{tr} \mathbf{D} + \det \mathbf{D} = 0$ .

Separation of real and imaginary parts in equation (89) yields

$$\text{Re} \lambda = -\frac{\mu_1 + \mu_2}{4} \delta \pm \sqrt{\frac{|c| + \text{Re} c}{2}}, \quad \text{Im} \lambda = \rho \pm \sqrt{\frac{|c| - \text{Re} c}{2}}, \quad (90)$$

where

$$\text{Re} c = \left( \frac{\mu_1 - \mu_2}{4} \right)^2 \delta^2 - \tilde{\Omega}^2 + \frac{\nu^2}{4\rho^2}, \quad \text{Im} c = \frac{\tilde{\Omega}\nu}{\rho}. \quad (91)$$

The formulas (89)-(91) describe splitting of the double eigenvalues at the nodes of the spectral mesh due to variation of parameters.

Assuming  $\nu = 0$  in formulas (90) we find that

$$\left( \text{Re} \lambda + \frac{\mu_1 + \mu_2}{4} \delta \right)^2 + \tilde{\Omega}^2 = \frac{(\mu_1 - \mu_2)^2}{16} \delta^2, \quad \text{Im} \lambda = \rho \quad (92)$$

when

$$\tilde{\Omega}^2 - \frac{(\mu_1 - \mu_2)^2}{16} \delta^2 < 0, \quad (93)$$

and

$$\tilde{\Omega}^2 - (\text{Im} \lambda - \rho)^2 = \frac{(\mu_1 - \mu_2)^2}{16} \delta^2, \quad \text{Re} \lambda = -\frac{\mu_1 + \mu_2}{4} \delta, \quad (94)$$

when the sign in inequality (93) is opposite. For a given  $\delta$  equation (94) defines a hyperbola in the plane  $(\tilde{\Omega}, \text{Im} \lambda)$ , while (92) is the equation of a circle in the plane  $(\tilde{\Omega}, \text{Re} \lambda)$ , as shown in Fig. 12(a,c). For tracking the complex eigenvalues due to change of the gyroscopic parameter  $\tilde{\Omega}$ , it is convenient to consider the eigenvalue branches in the three-dimensional space  $(\tilde{\Omega}, \text{Im} \lambda, \text{Re} \lambda)$ . In this space the circle belongs to the plane  $\text{Im} \lambda = \rho$  and the hyperbola lies in the plane  $\text{Re} \lambda = -\delta(\mu_1 + \mu_2)/4$ , see Fig. 13(a,c).

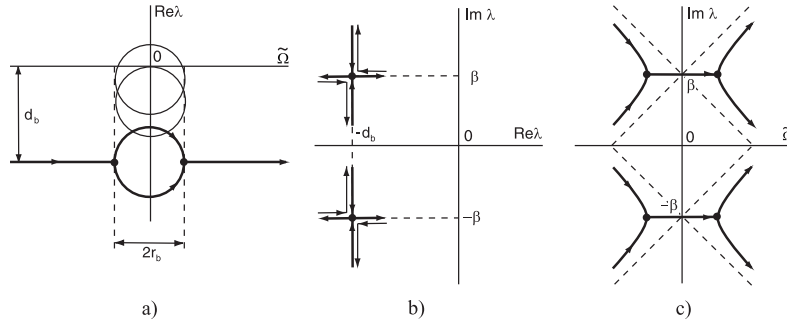

**Fig. 12.** Origination of a latent source of the subcritical flutter instability in presence of full dissipation: Submerged bubble of instability (a); coalescence of eigenvalues in the complex plane at two exceptional points (b); hyperbolic trajectories of imaginary parts (c).

The radius  $r_b$  of the circle of complex eigenvalues—*the bubble of instability*—and the distance  $d_b$  of its center from the plane  $\text{Re } \lambda = 0$  are expressed by means of the eigenvalues  $\mu_1$  and  $\mu_2$  of the matrix  $\mathbf{D}$

$$r_b = |(\mu_1 - \mu_2)\delta|/4, \quad d_b = |(\mu_1 + \mu_2)\delta|/4. \quad (95)$$

Consequently, the bubble of instability is “submerged” under the surface  $\text{Re } \lambda = 0$  in the space  $(\tilde{\Omega}, \text{Im } \lambda, \text{Re } \lambda)$  and does not intersect the plane  $\text{Re } \lambda = 0$  under the condition  $d_b \geq r_b$ , which is equivalent to the positive-definiteness of the matrix  $\delta\mathbf{D}$ . Hence, the role of full dissipation or pervasive damping is to deform the spectral mesh in such a way that the double semi-simple eigenvalue is inflated to the bubble of complex eigenvalues (92) connected with the two branches of the hyperbola (94) at the points

$$\text{Im } \lambda = \rho, \quad \text{Re } \lambda = -\delta(\mu_1 + \mu_2)/4, \quad \tilde{\Omega} = \pm\delta(\mu_1 - \mu_2)/4, \quad (96)$$

and to plunge all the eigenvalue curves into the region  $\text{Re } \lambda \leq 0$ . The eigenvalues at the points (96) are double and have a Jordan chain of order 2. In the complex plane the eigenvalues move with the variation of  $\tilde{\Omega}$  along the lines  $\text{Re } \lambda = -d_b$  until they meet at the points (96) and then split in the orthogonal direction; however, they never cross the imaginary axis, see Fig. 12(b).

The radius of the bubble of instability is greater than the depth of its submergence under the surface  $\text{Re } \lambda = 0$  only if the eigenvalues  $\mu_1$  and  $\mu_2$  of the damping matrix have different signs, i.e. if *the damping is indefinite*. The damping with the indefinite matrix appears in the systems with frictional contact when the friction coefficient is decreasing with relative sliding velocity [35, 36, 40]. Indefinite damping leads to the emersion of the bubble of instability meaning that the



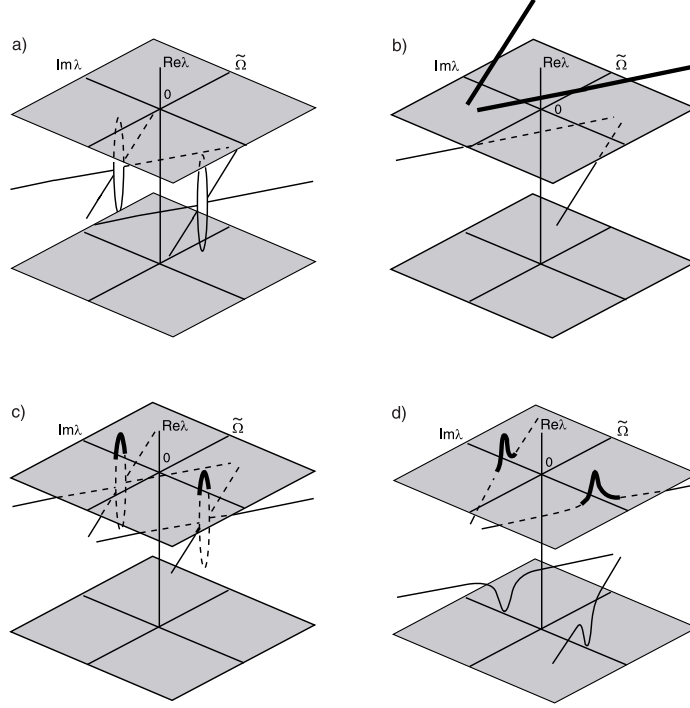

**Fig. 13.** The mechanism of subcritical flutter instability (bold lines): The ring (bubble) of complex eigenvalues submerged under the surface  $\text{Re}\lambda = 0$  due to action of dissipation with  $\det \mathbf{D} \geq 0$  - a latent source of instability (a); repulsion of eigenvalue branches of the spectral mesh due to action of non-conservative positional forces (b); emersion of the bubble of instability due to indefinite damping with  $\det \mathbf{D} < 0$  (c); collapse of the bubble of instability and immersion and emersion of its parts due to combined action of dissipative and non-conservative positional forces (d).

eigenvalues of the bubble have positive real parts in the range  $\tilde{\Omega}^2 < \tilde{\Omega}_{cr}^2$ , where  $\tilde{\Omega}_{cr} = \frac{\delta}{2} \sqrt{-\det \mathbf{D}}$ . Changing the damping matrix  $\delta \mathbf{D}$  from positive definite to indefinite we trigger the state of the bubble of instability from latent ( $\text{Re}\lambda < 0$ ) to active ( $\text{Re}\lambda > 0$ ), see Fig. 13(a,c). Since for small  $\delta$  we have  $\tilde{\Omega}_{cr} < \tilde{\Omega}_d$ , the flutter instability is subcritical and is localized in the neighborhood of the nodes of the spectral mesh at  $\tilde{\Omega} = 0$ .

In the absence of dissipation, the non-conservative positional forces destroy the marginal stability of gyroscopic systems [12, 13]. Indeed, assuming  $\delta = 0$  in the formula (89) we obtain

$$\lambda_p^\pm = i\rho \pm i\tilde{\Omega} \pm \frac{\nu}{2\rho}, \quad \lambda_n^\pm = -i\rho \pm i\tilde{\Omega} \mp \frac{\nu}{2\rho}. \quad (97)$$

According to (97), the eigenvalues of the branches  $i\rho + i\tilde{\Omega}$  and  $-i\rho - i\tilde{\Omega}$  of the spectral mesh get positive real parts due to perturbation by the non-conservative positional forces. The eigenvalues of the other two branches are shifted to the left from the imaginary axis, see Fig. 13(b).

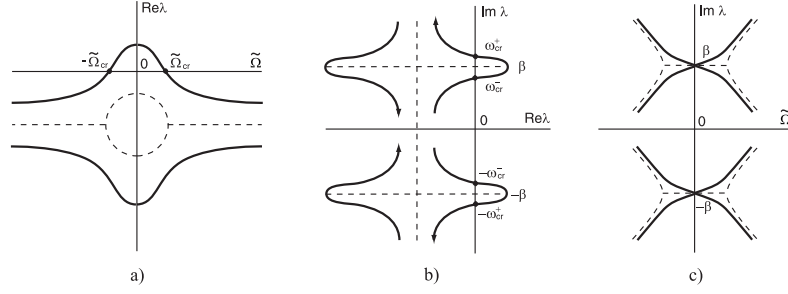

**Fig. 14.** Subcritical flutter instability due to combined action of dissipative and non-conservative positional forces: Collapse and emersion of the bubble of instability (a); excursions of eigenvalues to the right side of the complex plane when  $\tilde{\Omega}$  goes from negative values to positive (b); crossing of imaginary parts (c).

In contrast to the effect of indefinite damping the instability induced by the non-conservative forces only is not local. However, in combination with the dissipative forces, both definite and indefinite, the non-conservative forces can create subcritical flutter instability in the vicinity of diabolical points.

From equation (89) we find that in presence of dissipative and circulatory perturbations the trajectories of the eigenvalues in the complex plane are described by the formula

$$\left( \operatorname{Re} \lambda + \frac{\operatorname{tr} \mathbf{D}}{4} \delta \right) (\operatorname{Im} \lambda - \rho) = \frac{\tilde{\Omega} \nu}{2\rho}. \quad (98)$$

Non-conservative positional forces with  $\nu \neq 0$  destroy the merging of modes, shown in Fig. 12, so that the eigenvalues move along the separated trajectories. According to (98) the eigenvalues with  $|\operatorname{Im} \lambda|$  increasing due to an increase in  $|\tilde{\Omega}|$  move closer to the imaginary axis than the others, as shown in Fig 14(b). In the space  $(\tilde{\Omega}, \operatorname{Im} \lambda, \operatorname{Re} \lambda)$  the action of the non-conservative positional forces separates the bubble of instability and the adjacent hyperbolic eigenvalue branches into two non-intersecting curves, see Fig 13(d). The form of each of the new eigenvalue curves carries the memory about the original bubble of instability, so that the real parts of the eigenvalues can be positive for the values of the

gyroscopic parameter localized near  $\tilde{\Omega} = 0$  in the range  $\tilde{\Omega}^2 < \tilde{\Omega}_{\text{cr}}^2$ , where

$$\tilde{\Omega}_{\text{cr}} = \delta \frac{\text{tr} \mathbf{D}}{4} \sqrt{-\frac{\nu^2 - \delta^2 \rho^2 \det \mathbf{D}}{\nu^2 - \delta^2 \rho^2 (\text{tr} \mathbf{D}/2)^2}}. \quad (99)$$

follows from the equations (89)-(91).

The eigenfrequencies of the unstable modes from the interval  $\tilde{\Omega}^2 < \tilde{\Omega}_{\text{cr}}^2$  are localized near the frequency of the double semi-simple eigenvalue at the node of the undeformed spectral mesh:  $\omega_{\text{cr}}^- < \omega < \omega_{\text{cr}}^+$

$$\omega_{\text{cr}}^\pm = \rho \pm \frac{\nu}{2\rho} \sqrt{-\frac{\nu^2 - \delta^2 \rho^2 \det \mathbf{D}}{\nu^2 - \delta^2 \rho^2 (\text{tr} \mathbf{D}/2)^2}}. \quad (100)$$

When the radicand in formulas (99) and (100) is real, the eigenvalues make the excursion to right side of the complex plane, as shown in Fig. 14(b). In presence of non-conservative positional forces such excursions behind the stability boundary are possible, even when dissipation is full ( $\det \mathbf{D} > 0$ ).

The equation (99) describes the surface in the space of the parameters  $\delta$ ,  $\nu$ , and  $\tilde{\Omega}$ , which is an approximation to the stability boundary. Extracting the parameter  $\nu$  in (99) yields

$$\nu = \pm \delta \rho \text{tr} \mathbf{D} \sqrt{\frac{\delta^2 \det \mathbf{D} + 4\tilde{\Omega}^2}{\delta^2 (\text{tr} \mathbf{D})^2 + 16\tilde{\Omega}^2}}. \quad (101)$$

If  $\det \mathbf{D} \geq 0$  and  $\tilde{\Omega}$  is fixed, the formula (101) describes two independent curves in the plane  $(\delta, \nu)$  intersecting with each other at the origin along the straight lines given by the expression

$$\nu = \pm \frac{\rho \text{tr} \mathbf{D}}{2} \delta. \quad (102)$$

However, in case when  $\det \mathbf{D} < 0$ , the radical in (101) is real only for  $\delta^2 < -4\tilde{\Omega}^2 / \det \mathbf{D}$  meaning that (101) describes two branches of a closed loop in the plane of the parameters  $\delta$  and  $\nu$ . The loop is self-intersecting at the origin with the tangents given by the expression (102). Hence, the shape of the surface described by equation (101) is a cone with the "8"-shaped loop in a cross-section, see Fig. 15(a). The asymptotic stability domain is inside the two of the four pockets of the cone, selected by the inequality  $\delta \text{tr} \mathbf{D} > 0$ , as shown in Fig. 15(a). The singularity of the stability domain at the origin is the degeneration of a more general configuration shown in Fig. 5(b).

The domain of asymptotic stability bifurcates when  $\det \mathbf{D}$  changes from negative to positive values. This process is shown in Fig. 15. In case of indefinite damping there exists an instability gap due to the singularity at the origin. Starting in the flutter domain at  $\tilde{\Omega} = 0$  for any combination of the parameters

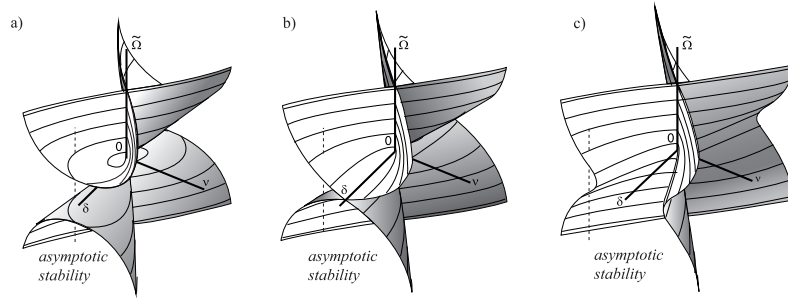

**Fig. 15.** Domains of asymptotic stability in the space  $(\delta, \nu, \tilde{\Omega})$  for different types of damping: Indefinite damping  $\det \mathbf{D} < 0$  (a); semi-definite (pervasive) damping  $\det \mathbf{D} = 0$  (b); full dissipation  $\det \mathbf{D} > 0$  (c).

$\delta$  and  $\nu$  one can reach the domain of asymptotic stability at higher values of  $|\tilde{\Omega}|$  (gyroscopic stabilization), as shown in Fig. 15(a) by the dashed line. The gap is responsible for the subcritical flutter instability localized in the vicinity of the node of the spectral mesh of the unperturbed gyroscopic system. When  $\det \mathbf{D} = 0$ , the gap vanishes in the direction  $\nu = 0$ . In case of full dissipation ( $\det \mathbf{D} > 0$ ) the singularity at the origin unfolds. However, the memory about it is preserved in the two instability gaps located in the folds of the stability boundary with the locally strong curvature, Fig. 15(c). At some values of  $\delta$  and  $\nu$  one can penetrate the fold of the stability boundary with the change of  $\Omega$ , as shown in Fig. 15(c) by the dashed line. For such  $\delta$  and  $\nu$  the flutter instability is localized in the vicinity of  $\tilde{\Omega} = 0$ .

The phenomenon of the local subcritical flutter instability is controlled by the eigenvalues of the matrix  $\mathbf{D}$ . When both of them are positive, the folds of the stability boundary are more pronounced if one of the eigenvalues is close to zero. If one of the eigenvalues is negative and the other is positive, the local subcritical flutter instability is possible for any combination of  $\delta$  and  $\nu$  including the case when the non-conservative positional forces are absent ( $\nu = 0$ ).

The instability mechanism behind the squealing disc brake or singing wine glass can be described as the emersion (or activation) due to indefinite damping and non-conservative positional forces of the bubbles of instability created by the full dissipation in the vicinity of the nodes of the spectral mesh.

## Conclusions

Investigation of stability and sensitivity analysis of the critical parameters and critical frequencies of near-Hamiltonian and near-reversible systems is complicated by the singularities of the boundary of asymptotic stability domain, which

are related to the multiple eigenvalues. In the paper we have developed the methods of approximation of the stability boundaries near the singularities and obtained estimates of the critical values of parameters in the case of arbitrary number of degrees of freedom using the perturbation theory of eigenvalues and eigenvectors of non-self-adjoint operators. In case of two degrees of freedom the domain of asymptotic stability of near-reversible and near-Hamiltonian systems is fully described and its typical configurations are found. Bifurcation of the stability domain due to change of the matrix of dissipative forces is discovered and described. Two classes of indefinite damping matrices are found and the explicit threshold, separating the weakly- and strongly indefinite matrices is derived. The role of dissipative and non-conservative forces in the paradoxical effects of gyroscopic stabilization of statically unstable potential systems as well as of destabilization of statically stable ones is clarified. Finally, the mechanism of subcritical flutter instability in rotating elastic bodies of revolution in frictional contact, exciting oscillations in the squealing disc brake and in the singing wine glass, is established.

## Acknowledgments

The author is grateful to Professor P. Hagedorn for his interest to this work and useful discussions.

## References

1. W. THOMSON AND P. G. TAIT, *Treatise on Natural Philosophy*, Vol. 1, Part 1, New Edition, Cambridge Univ. Press, Cambridge, 1879.
2. E. J. ROUTH, *A treatise on the stability of a given state of motion*, Macmillan, London, 1892.
3. A. L. KIMBALL, *Internal friction theory of shaft whirling*, Phys. Rev., 21(6) (1923), pp. 703.
4. D. M. SMITH, *The motion of a rotor carried by a flexible shaft in flexible bearings*, Proc. Roy. Soc. Lond. A., 142 (1933), pp. 92–118.
5. P. L. KAPITSA, *Stability and transition through the critical speed of fast rotating shafts with friction*, Zh. Tekh. Fiz., 9 (1939), pp. 124–147.
6. H. BILHARZ, *Bemerkung zu einem Satze von Hurwitz*, Z. angew. Math. Mech., 24(2) (1944), pp. 77–82.
7. M. G. KREIN, *A generalization of some investigations of linear differential equations with periodic coefficients*, Doklady Akad. Nauk SSSR N.S., 73 (1950), pp. 445–448.
8. H. ZIEGLER, *Die Stabilitätskriterien der Elastomechanik*, Ing.-Arch., 20 (1952), pp. 49–56.
9. E. O. HOLOPAINEN, *On the effect of friction in baroclinic waves*, Tellus, 13(3) (1961), pp. 363–367.

10. V. V. BOLOTIN, *Non-conservative Problems of the Theory of Elastic Stability*, Pergamon, Oxford, 1963.
11. G. HERRMANN AND I. C. JONG, *On the destabilizing effect of damping in non-conservative elastic systems*, ASME J. of Appl. Mechs., 32(3) (1965), pp. 592–597.
12. V. M. LAKHADANOV, *On stabilization of potential systems*, Prikl. Mat. Mekh., 39(1) (1975), pp. 53–58.
13. A. V. KARAPETYAN, *On the stability of nonconservative systems*, Vestn. MGU. Ser. Mat. Mekh., 4 (1975), pp. 109–113.
14. W. HAUGER, *Stability of a gyroscopic non-conservative system*, Trans. ASME, J. Appl. Mech., 42 (1975), pp. 739–740.
15. I. P. ANDREICHIKOV AND V. I. YUDOVICH, *The stability of visco-elastic rods*, Izv. Acad. Nauk SSSR. MTT, 1 (1975), pp. 150–154.
16. V. N. TKHAI, *On stability of mechanical systems under the action of position forces*, PMM U.S.S.R., 44 (1981), pp. 24–29.
17. V. I. ARNOLD, *Geometrical Methods in the Theory of Ordinary Differential Equations*, Springer, New York and Berlin, 1983.
18. A. S. DEIF, P. HAGEDORN, *Matrix polynomials subjected to small perturbations*. Z. angew. Math. Mech., 66 (1986), pp. 403–412.
19. M. B. SEVRYUK, *Reversible systems*, Lecture Notes in Mathematics 1211, Springer, Berlin, 1986.
20. N. V. BANICHUK, A. S. BRATUS, A. D. MYSHKIS, *Stabilizing and destabilizing effects in nonconservative systems*, PMM U.S.S.R., 53(2) (1989), pp. 158–164.
21. S. BARNETT, *Leverrier's algorithm: a new proof and extensions*, SIAM J. Matrix Anal. Appl., 10(4) (1989), pp. 551–556.
22. A. P. SEYRANIAN, *Destabilization paradox in stability problems of non-conservative systems*, Advances in Mechanics, 13(2) (1990), 89–124.
23. R. S. MACKAY, *Movement of eigenvalues of Hamiltonian equilibria under non-Hamiltonian perturbation*, Phys. Lett. A, 155 (1991), 266–268.
24. H. LANGER, B. NAJMAN, K. VESELIĆ, *Perturbation of the eigenvalues of quadratic matrix polynomials*, SIAM J. Matrix Anal. Appl. 13(2) (1992), pp. 474–489.
25. G. HALLER, *Gyroscopic stability and its loss in systems with two essential coordinates*, Intern. J. of Nonl. Mechs., 27 (1992), 113–127.
26. A. N. KOUNADIS, *On the paradox of the destabilizing effect of damping in non-conservative systems*, Intern. J. of Nonl. Mechs., 27 (1992), 597–609.
27. V. F. ZHURAVLEV, *Nutational vibrations of a free gyroscope*, Izv. Ross. Akad. Nauk, Mekh. Tverd. Tela, 6 (1992), 13–16.
28. A. M. BLOCH, P. S. KRISHNAPRASAD, J. E. MARSDEN, T. S. RATIU, *Dissipation-induced instabilities*, Annales de l'Institut Henri Poincaré, 11(1) (1994), pp. 37–90.
29. J. MADDOCKS AND M. L. OVERTON, *Stability theory for dissipatively perturbed Hamiltonian systems*, Comm. Pure and Applied Math., 48 (1995), pp. 583–610.
30. I. HOVEIJN AND M. RUIJGROK, *The stability of parametrically forced coupled oscillators in sum resonance*, Z. angew. Math. Phys., 46 (1995), pp. 384–392.
31. S. H. CRANDALL, *The effect of damping on the stability of gyroscopic pendulums*, Z. angew. Math. Phys., 46 (1995), pp. 761–780.
32. V. V. BELETSKY, *Some stability problems in applied mechanics*, Appl. Math. Comp., 70 (1995), pp. 117–141.

33. O. M. O'REILLY, N. K. MALHOTRA, N. S. NAMACHCHIVAYA, *Some aspects of destabilization in reversible dynamical systems with application to follower forces*, *Nonlin. Dyn.* 10 (1996), pp. 63–87.
34. D. R. MERKIN, *Introduction to the Theory of Stability*, Springer, Berlin, 1997.
35. P. FREITAS, M. GRINFELD, P. A. KNIGHT, *Stability of finite-dimensional systems with indefinite damping*, *Adv. Math. Sci. Appl.* 7(1) (1997), pp. 437–448.
36. W. KLIEM AND P. C. MÜLLER, *Gyroscopic stabilization of indefinite damped systems*. *Z. angew. Math. Mech.* 77(1) (1997), pp. 163–164.
37. R. HRYNIV AND P. LANCASTER, *On the perturbation of analytic matrix functions*, *Integral Equations And Operator Theory*, 34(3) (1999), pp. 325–338.
38. R. HRYNIV AND P. LANCASTER, *Stabilization of gyroscopic systems*. *Z. angew. Math. Mech.* 81(10) (2001), pp. 675–681.
39. V. V. BOLOTIN, A. A. GRISHKO, M. YU. PANOV, *Effect of damping on the postcritical behavior of autonomous non-conservative systems*, *Intern. J. of Nonl. Mechs.* 37 (2002), pp. 1163–1179.
40. K. POPP, M. RUDOLPH, M. KRÖGER, M. LINDNER, *Mechanisms to generate and to avoid friction induced vibrations*, VDI-Berichte 1736, VDI-Verlag, Düsseldorf, 2002.
41. P. LANCASTER, A. S. MARKUS, F. ZHOU, *Perturbation theory for analytic matrix functions: The semisimple case*, *SIAM J. Matrix Anal. Appl.* 25(3) (2003), pp. 606–626.
42. N. HOFFMANN AND L. GAUL, *Effects of damping on mode-coupling instability in friction induced oscillations*, *Z. angew. Math. Mech.* 83 (2003), pp. 524–534.
43. O. N. KIRILLOV, *How do small velocity-dependent forces (de)stabilize a non-conservative system?*, DCAMM Report 681, Lyngby, 2003.
44. A. P. SEIRANYAN AND O. N. KIRILLOV, *Effect of small dissipative and gyroscopic forces on the stability of nonconservative systems*, *Doklady Physics*, 48(12) (2003), pp. 679–684.
45. W. F. LANGFORD, *Hopf meets Hamilton under Whitney's umbrella*, in IUTAM symposium on nonlinear stochastic dynamics. Proceedings of the IUTAM symposium, Monticello, IL, USA, Augsut 26-30, 2002, *Solid Mech. Appl.* 110, S. N. Namachchivaya, et al., eds., Kluwer, Dordrecht, 2003, pp. 157–165.
46. A. P. IVANOV, *The stability of mechanical systems with positional non-conservative forces*, *J. Appl. Maths. Mechs.* 67(5) (2003), pp. 625–629.
47. A. P. SEYRANIAN AND A. A. MAILYBAEV, *Multiparameter stability theory with mechanical applications*, World Scientific, Singapore, 2003.
48. N. M. BOU-RABEE, J. E. MARSDEN, L. A. ROMERO, *Tippe Top inversion as a dissipation-induced instability*, *SIAM J. Appl. Dyn. Sys.* 3 (2004), pp. 352–377.
49. H. K. MOFFATT, Y. SHIMOMURA, M. BRANICKI, *Dynamics of an axisymmetric body spinning on a horizontal surface. I. Stability and the gyroscopic approximation*, *Proc. Roy. Soc. Lond. A* 460 (2004), pp. 3643–3672.
50. O. N. KIRILLOV, *Destabilization paradox*, *Doklady Physics*. 49(4) (2004), pp. 239–245.
51. O. N. KIRILLOV, A. P. SEYRANIAN, *Collapse of the Keldysh chains and stability of continuous nonconservative systems*, *SIAM J. Appl. Math.* 64(4) (2004), pp. 1383–1407.
52. O. N. KIRILLOV AND A. P. SEYRANIAN, *Stabilization and destabilization of a circulatory system by small velocity-dependent forces*, *J. Sound and Vibr.*, 283(3–5) (2005), pp. 781–800.

53. O. N. KIRILLOV, *A theory of the destabilization paradox in non-conservative systems*, Acta Mechanica, 174(3-4) (2005), pp. 145-166.
54. O. N. KIRILLOV AND A. P. SEYRANIAN, *Instability of distributed nonconservative systems caused by weak dissipation*, Doklady Mathematics, 71(3) (2005), pp. 470-475.
55. O. N. KIRILLOV AND A. O. SEYRANIAN, *The effect of small internal and external damping on the stability of distributed non-conservative systems*, J. Appl. Math. Mech., 69(4) (2005), pp. 529-552.
56. P. LANCASTER, P. PSARRAKOS, *On the Pseudospectra of Matrix Polynomials*, SIAM J. Matrix Anal. Appl., 27(1) (2005), pp. 115-120.
57. A. P. SEYRANIAN, O. N. KIRILLOV, A. A. MAILYBAEV, *Coupling of eigenvalues of complex matrices at diabolic and exceptional points*. J. Phys. A: Math. Gen., 38(8) (2005), pp. 1723-1740.
58. O. N. KIRILLOV, A. A. MAILYBAEV, A. P. SEYRANIAN, *Unfolding of eigenvalue surfaces near a diabolic point due to a complex perturbation*, J. Phys. A: Math. Gen., 38(24) (2005), pp. 5531-5546.
59. N. M. BOU-RABEE, J. E. MARSDEN, L. A. ROMERO, *A geometric treatment of Jellet's egg*, Z. angew. Math. Mech., 85(9) (2005), pp. 618-642.
60. A. A. MAILYBAEV, O. N. KIRILLOV, A. P. SEYRANIAN, *Berry phase around degeneracies*, Dokl. Math., 73(1) (2006), pp. 129-133.
61. T. BUTLIN, J. WOODHOUSE, *Studies of the Sensitivity of Brake Squeal*, Appl. Mech. and Mater., 5-6 (2006), pp. 473-479.
62. R. KRECHETNIKOV AND J. E. MARSDEN, *On destabilizing effects of two fundamental non-conservative forces*, Physica D, 214 (2006), pp. 25-32.
63. O. N. KIRILLOV, *Gyroscopic stabilization of non-conservative systems*, Phys. Lett. A, 359(3) (2006), pp. 204-210.
64. U. GÜNTHER, O. N. KIRILLOV, *A Krein space related perturbation theory for MHD alpha-2 dynamos and resonant unfolding of diabolical points*, J. Phys. A: Math. Gen., 39 (2006), pp. 10057-10076
65. V. KOBEL'EV, *Sensitivity analysis of the linear nonconservative systems with fractional damping*, Struct. Multidisc. Optim., 33 (2007), pp. 179-188.
66. R. KRECHETNIKOV AND J. E. MARSDEN, *Dissipation-induced instabilities in finite dimensions*, Rev. Mod. Phys., 79 (2007), pp. 519-553.
67. U. VON WAGNER, D. HOCHLENERT, P. HAGEDORN, *Minimal models for disk brake squeal*, J. Sound Vibr., 302(3) (2007), pp. 527-539.
68. O. N. KIRILLOV, *On the stability of nonconservative systems with small dissipation*, J. Math. Sci., 145(5) (2007), pp. 5260-5270.
69. A. N. KOUNADIS, *Flutter instability and other singularity phenomena in symmetric systems via combination of mass distribution and weak damping*, Int. J. of Non-Linear Mech., 42(1) (2007), pp. 24-35.
70. O. N. KIRILLOV, *Destabilization paradox due to breaking the Hamiltonian and reversible symmetry*, Int. J. of Non-Linear Mech., 42(1) (2007), pp. 71-87.
71. G. SPELSBERG-KORSPETER, D. HOCHLENERT, O. N. KIRILLOV, P. HAGEDORN, *In- and out-of-plane vibrations of a rotating plate with frictional contact: Investigations on squeal phenomena*, Trans. ASME, J. Appl. Mech., (2007) (submitted).
72. J.-J. SINOÛ AND L. JEZEQUEL, *Mode coupling instability in friction-induced vibrations and its dependency on system parameters including damping*, Eur. J. Mech. A., 26 (2007), 106-122.



73. P. KESSLER, O. M. O'REILLY, A.-L. RAPHAEL, M. ZWORSKI, *On dissipation-induced destabilization and brake squeal: A perspective using structured pseudospectra*, J. Sound Vibr., 308 (2007), 1-11.
74. O. N. KIRILLOV *Gyroscopic stabilization in the presence of non-conservative forces*, Dokl. Math., 76(2) (2007), pp. 780-785.
75. G. SPELSBERG-KORSPETER, O. N. KIRILLOV, P. HAGEDORN, *Modeling and stability analysis of an axially moving beam with frictional contact*, Trans. ASME, J. Appl. Mech. 75(3) (2008), 031001.
76. O. N. KIRILLOV, *Subcritical flutter in the acoustics of friction*, Proc. R. Soc. A, 464 (2008), pp.
77. J. KANG, C. M. KROUSGRILL, F. SADEGHI, *Dynamic instability of a thin circular plate with friction interface and its application to disc brake squeal*, J. Sound. Vibr. (2008).